

## Preparation:

- Disconnect the negative battery terminal. Park the vehicle on level ground and set the emergency brake.
- We recommend reading through the installation instructions in whole before performing the work.
- When button head bolts are being used, install the supplied washer on the nut side. Then, hold the bolt stationary and only turn the nut to tighten. Do not turn the bolt to tighten hardware assembly, unless otherwise noted.
- Estimated Installation Time: **4 Hours**

**\*\*This installation requires 2 people for best results\*\***

**\*\*Labor Rates are based on a vehicle with no pre-existing damage. Wiring labor is based on a standard wiring procedure with light switches installed in an easily accessible location. Custom light triggering or switch mounting location will result in a greater labor charge.\*\***

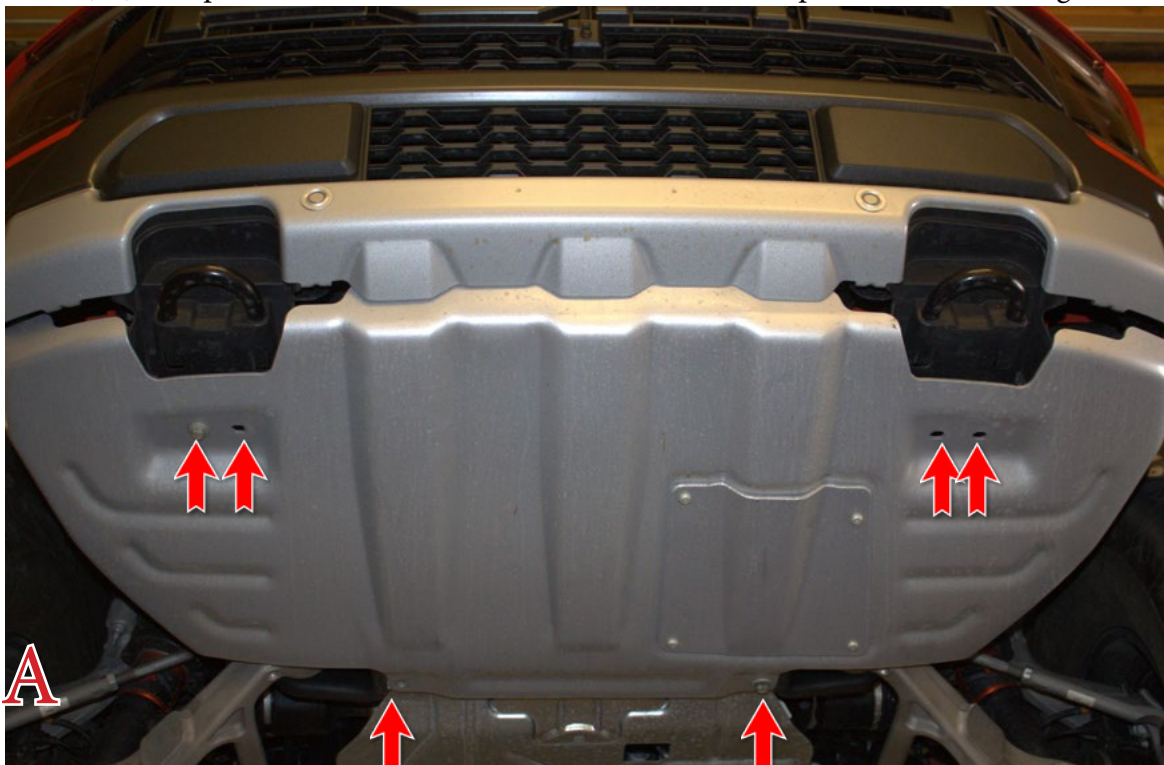
## You will need the following tools:

- |                           |                           |                           |
|---------------------------|---------------------------|---------------------------|
| - Ratchet                 | - 9/16" Socket & Wrench   | - 13mm Socket             |
| - 15mm Socket & Wrench    | - 18mm Socket             | - Long Ratchet Extension  |
| - Ratchet                 | - 7mm Socket              | - 8mm Socket              |
| - 10mm Socket             | - 11mm Socket             | - 13mm Socket             |
| - 15mm Socket             | - 8mm Wrench              | - 13mm Wrench             |
| - T27 Torx Bit            | - E6 External Torx Socket | - 3mm Allen Wrench/Socket |
| - 5mm Allen Wrench/Socket | - Masking Tape            | - Cutoff Wheel            |

## Included in Kit:

- |  |  |
|--|--|
| 2 - Hex Head Bolts (M8-1.25 x 16mm)        | 1 - Socket Head Bolt (M4-0.7 x 10mm)   |
| 3 - Flat Washers (M8) 1 - Flat Washer (#6) | 1 - Nylon Lock Nuts (M8-1.25)          |
| 1 - Socket Head Bolt (M6-1.0 x 18mm)       | 6 - Button Head Bolts (3/8"-16 x 3/4") |
| 6 - Flat Washers (3/8")                    | 6 - Nylon Lock Nuts (3/8"-16)          |
| 1 - Rubber Cap                             | 1 - Zip Tie                            |

1. Remove the (x6) skid plate bolts which are 13mm, then remove skid plate from truck. "Fig B"



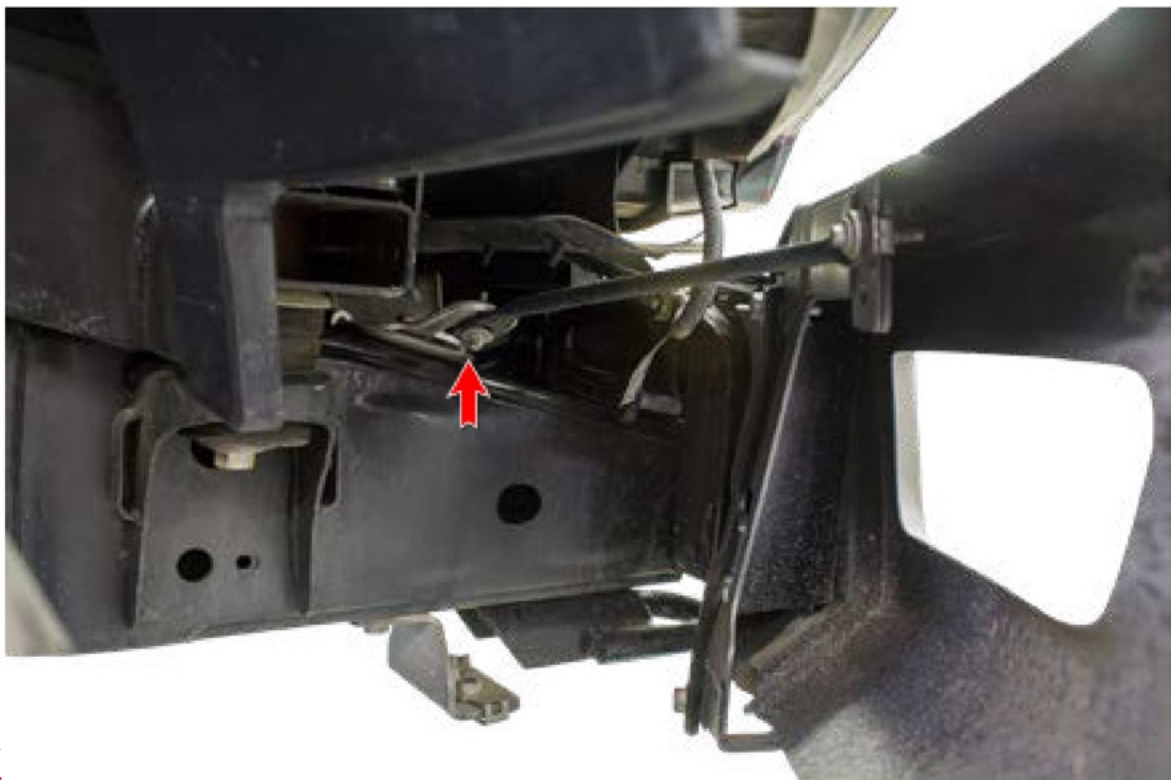
**Fig A**

2. Remove the metal spacer that the bottom two skid plate bolts go through. "Fig B"



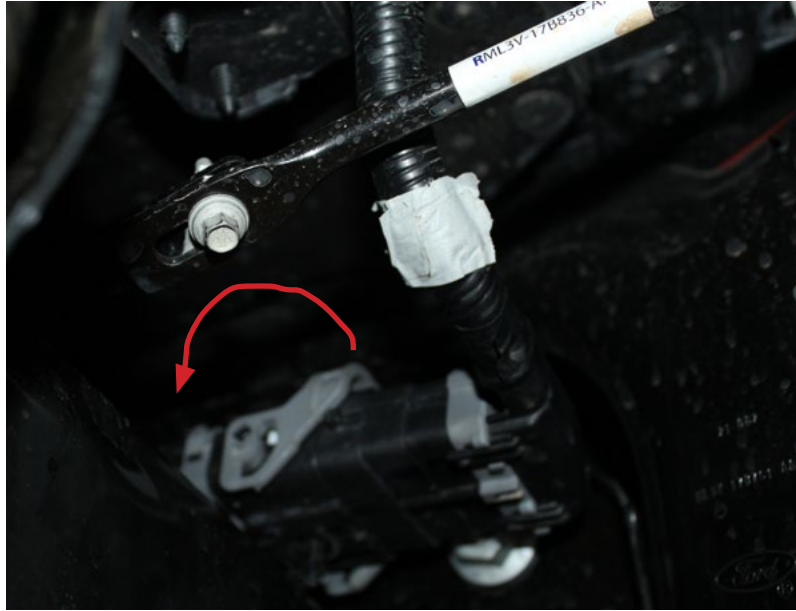
**Fig B**

3. Use an 8mm Socket to remove the bolt that holds on the bumper side support bar. Repeat this step on the other side of the vehicle. "Fig C"



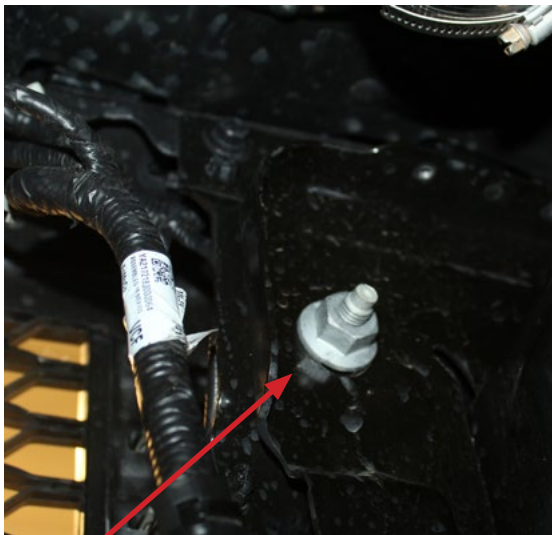
**Fig C**

4. This is also a good time to disconnect the main wiring harness from the bumper which will be located by the side support that was just removed in "fig ". To disconnect harness pull lever back 180 degrees then pull out. "Fig D"

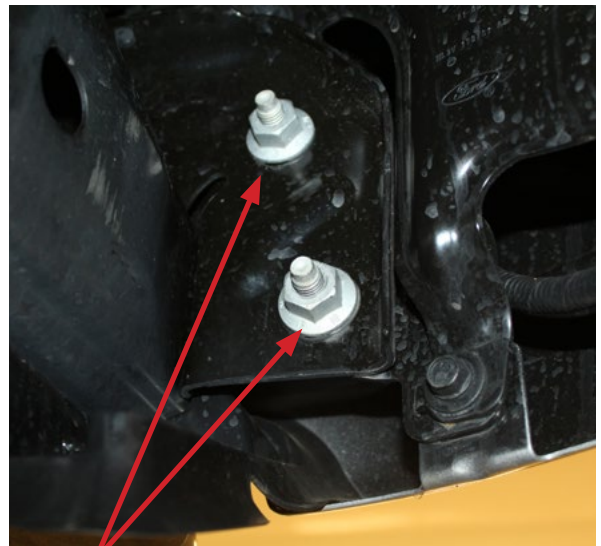


**Fig D**

5. Use a 21mm Socket to remove the nuts that hold on the front bumper. There are three per side. Two of the nuts (per side) face the front. One of the nuts (per side) faces the rear of the vehicle and is accessible from underneath the truck. After that the bumper can be removed. "Fig E"



**1 inner bolt**



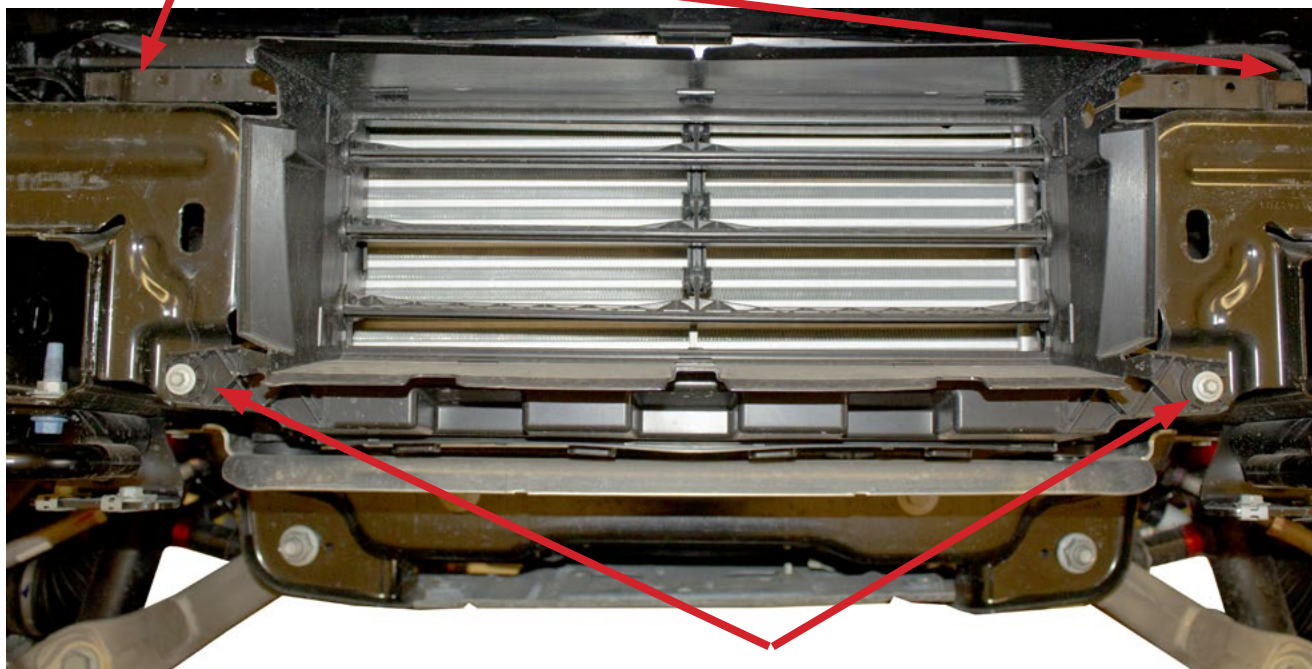
**2 outer bolts**

**Fig E**



6. Remove intercooler guard, first disconnect the plug on the driver side on the top of the intercooler guard by the bolt. Then, remove the 2 top bolts then the 2 bottom bolts. "Fig F"

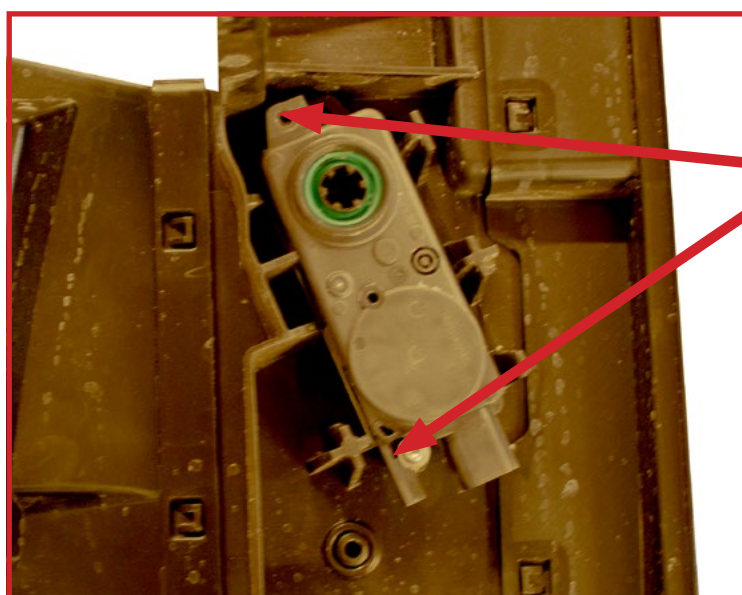
**2 Bolts on top**



**2 Bolts on the bottom**

**Fig F**

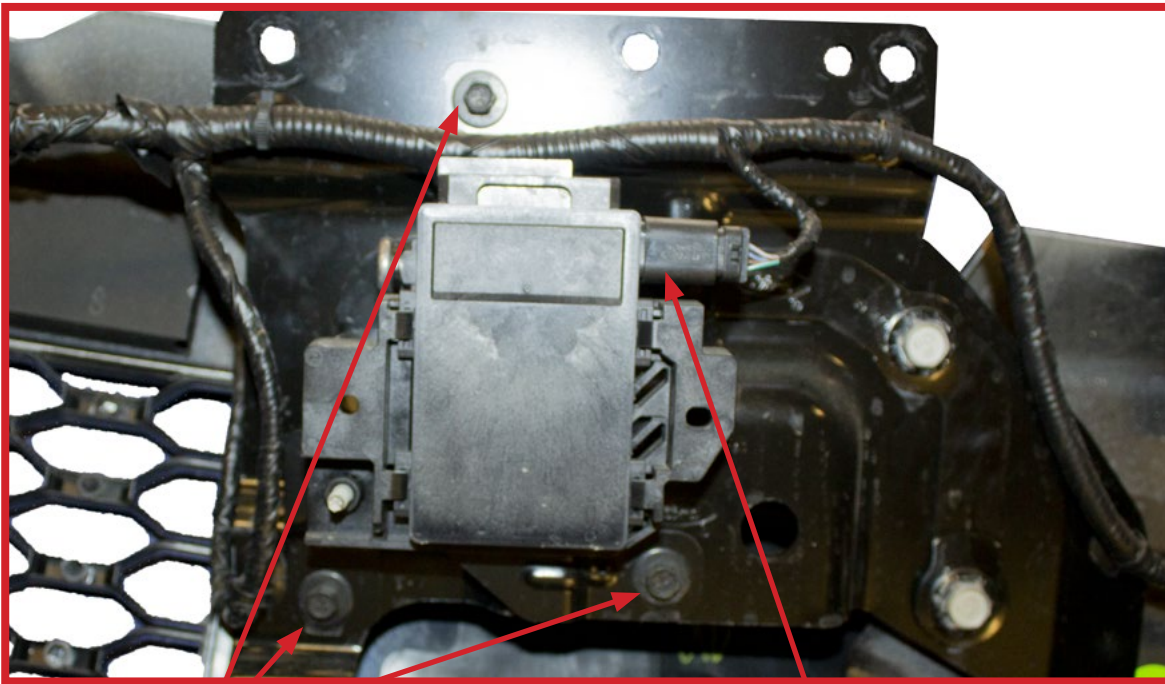
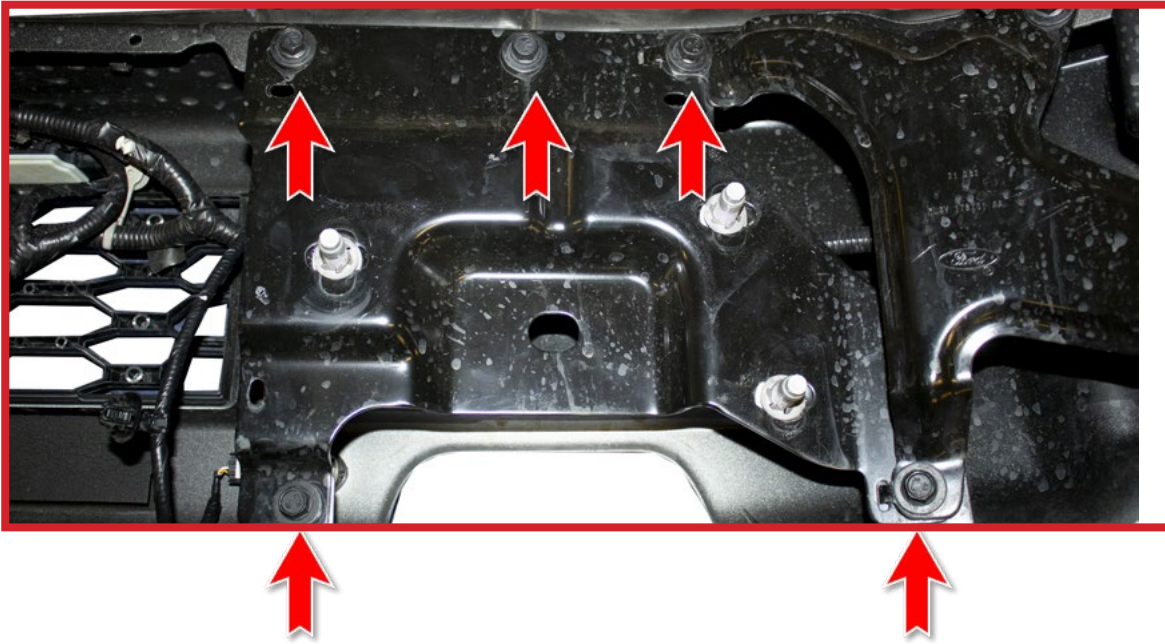
7. Remove the shutter motor from the intercooler guard. It is held in place by 2 bolts then can be pulled out then re-connected back into the wiring harness and zip tied on the ADD bumper. "Fig G"



**2 Bolts**

**Fig G**

8. There are 2 brackets on each side of the bumper that need to be disassembled to get to the Adaptive cruise control and harness. There are 5, 10mm bolts to remove the bracket. When unbolting the bracket that contains the Cruise Control Device, make sure to disconnect it. "Fig H"



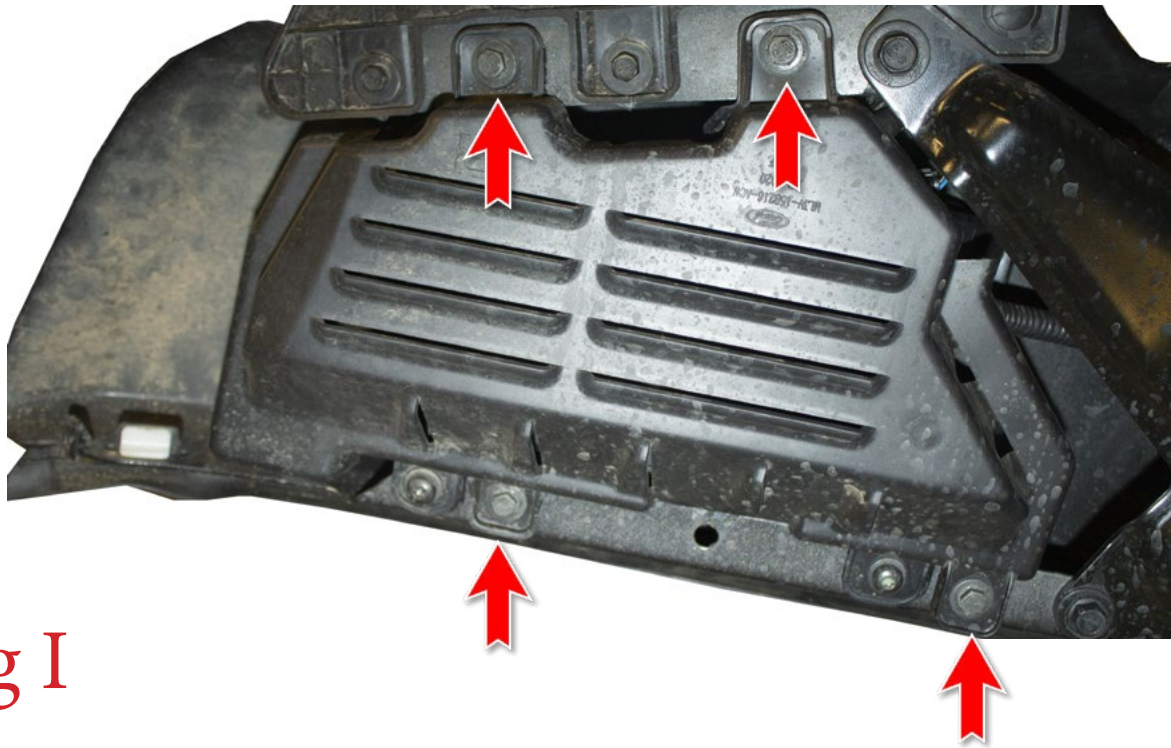
**Remove 3 bolts holding  
cruise control**

**Disconnect Cruise  
control**

**Fig H**

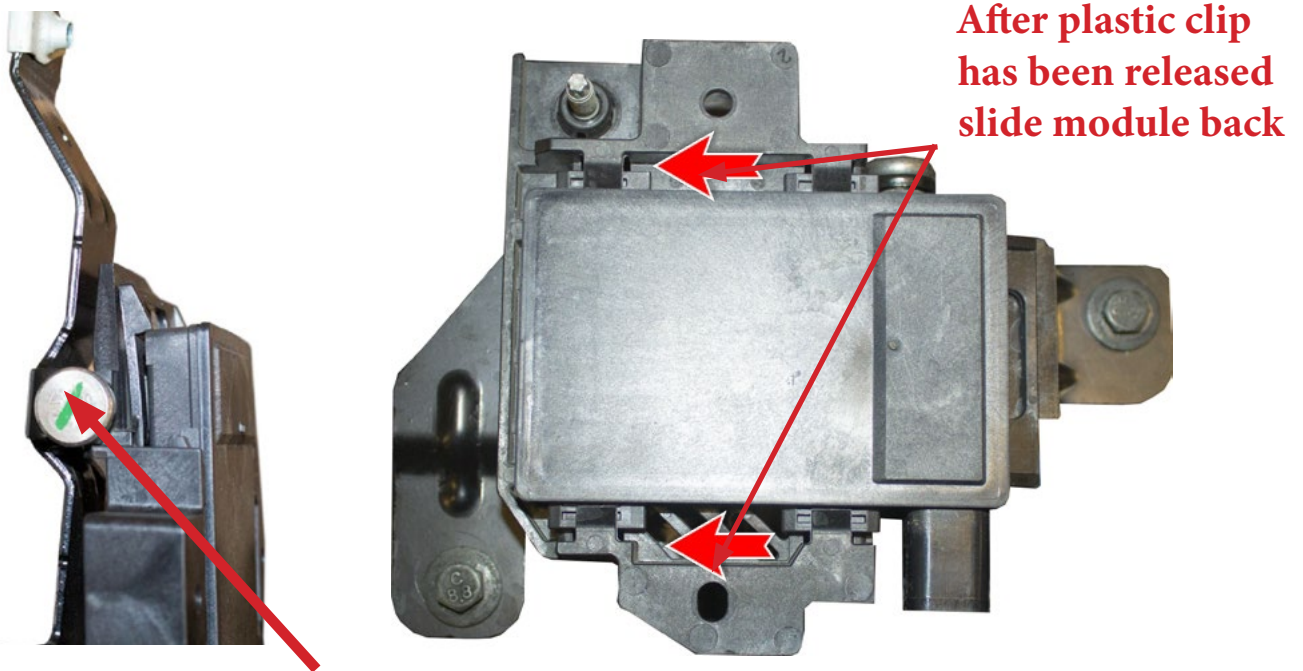


9. There are 4 bolts that hold the plastic covers where the rigid lights are located as well as the outer sensors. After the cover has been pulled off unplug the rigid lights and sensors. "Fig I"



**Fig I**

10. Release the plastic clip holding the adaptive cruise control module to its bracket. Then, remove the module from its brake by pulling back to slide it out. "Fig I"



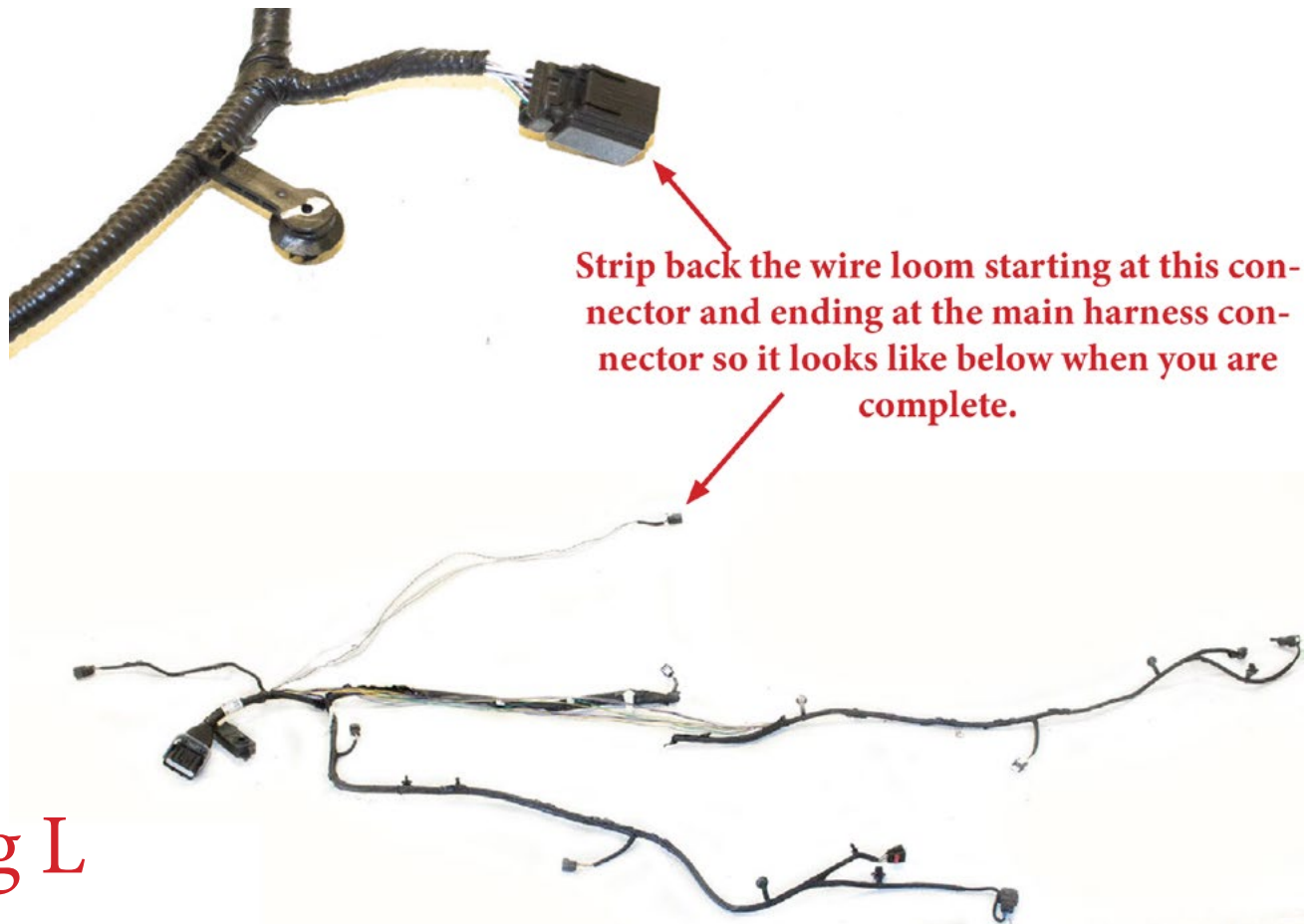
**Fig J** Release the plastic clip

11. Remove the series of plastic clips holding the front bumper harness to the OEM bumper. Then, remove the harness from the bumper. "Fig K"



**Fig K**

12. Find the section of the bumper harness that goes to the adaptive cruise control bracket. Cut the wire loom from this point all the way back to the main connector so you can separate the adaptive cruise wires from the rest of the harness. Once you have all the wires separated you can re-loom everything. "Fig L"



**Fig L**



13. Pop the hood and remove the radiator cover clips (14x). Then, remove the radiator cover from the vehicle.  
"Fig M"



**Fig M**

14. Use a 10mm Socket to remove the upper grille mounting bolts. "Fig N"



**Fig N**

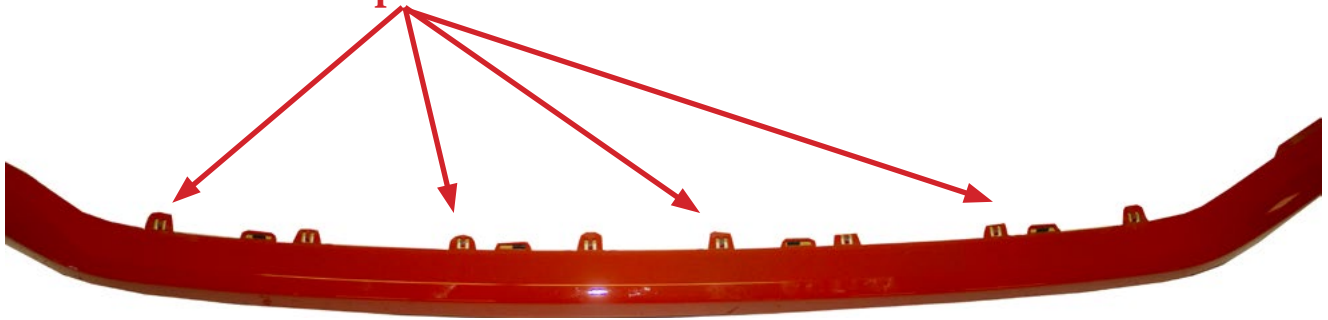


15. Pull the valance off the vehicle. There are no tools required for this step, it simply pulls off by hand. "Fig O"



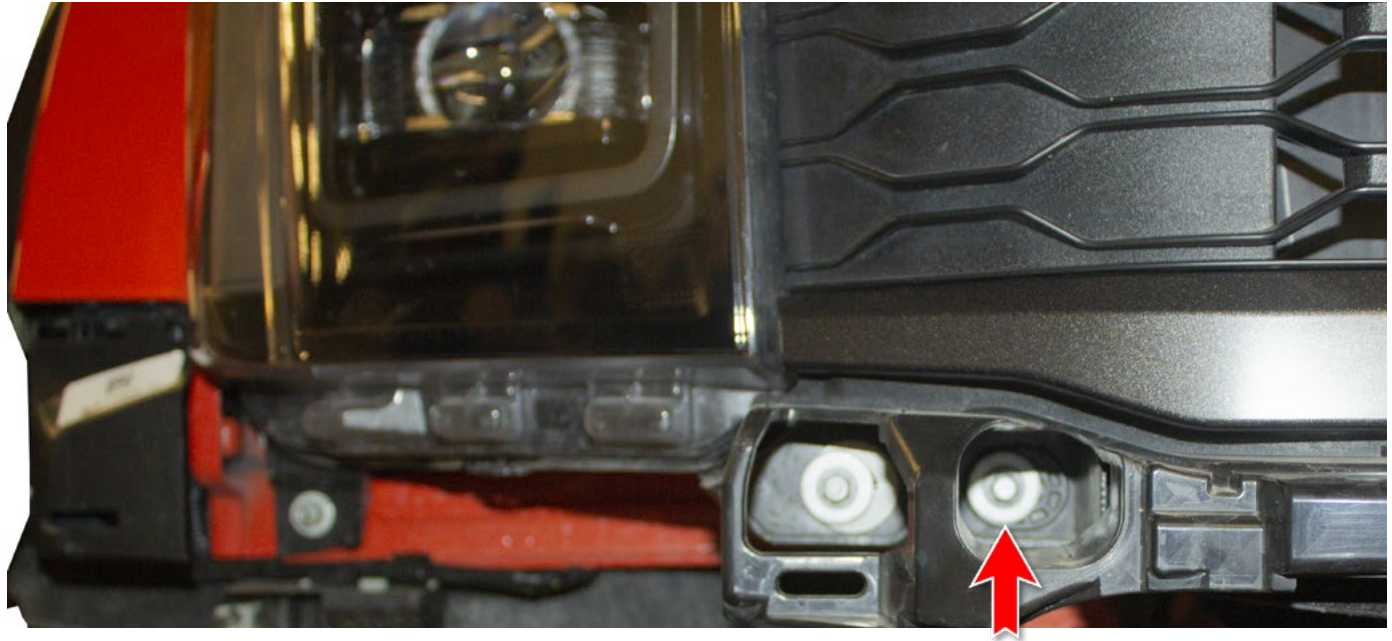
**Pull fender back to remove the clip that was attached to Valance**

**Pull off and it will unclip**



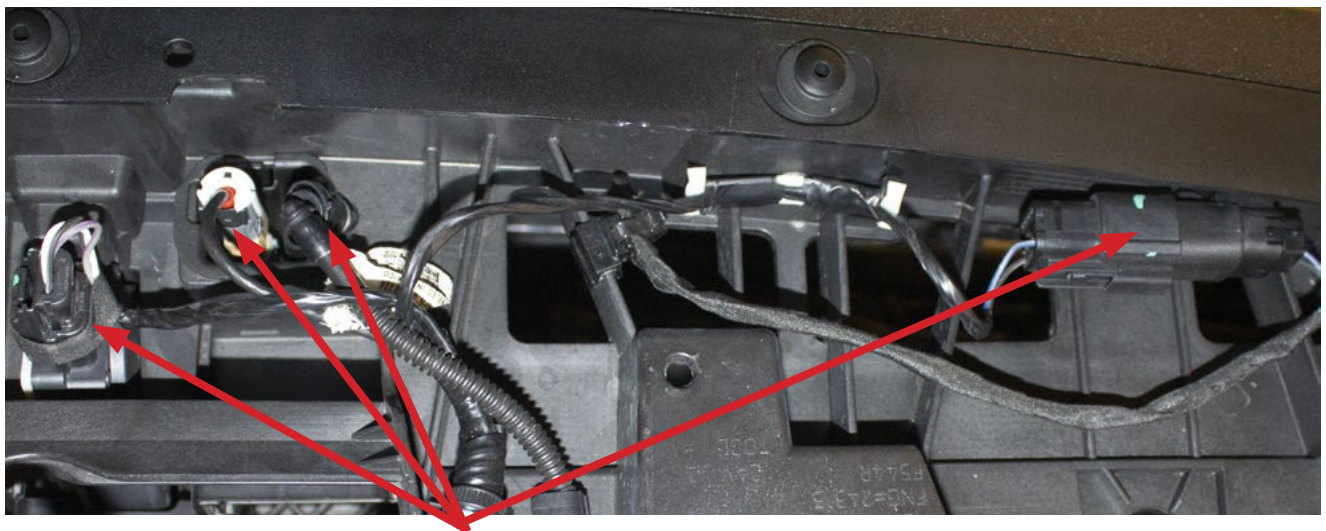
**Fig O**

16. Use an 8mm Socket to remove the lower grille mounting bolts (1 per side). "Fig P"



**Fig P**

17. Unplug the three connectors on the top side of the grille and release the two plastic clips holding the wires to the grille. Then, remove the grille from the vehicle. "Fig Q"



**Fig Q**

**Unplug these 4  
connectors**

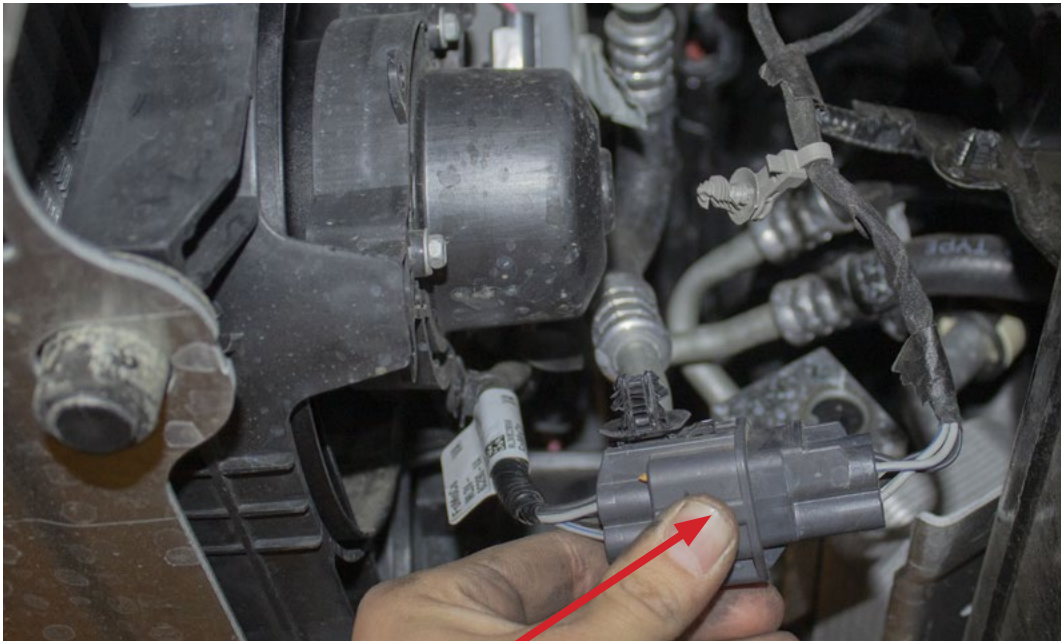


18. Using a 13mm Socket, remove the bolts that hold upper intercooler brace in place on top of the frame. There is one bolt per side. Then remove the upper intercooler brace. Save these bolts for reuse. "Fig R"



**Fig R**

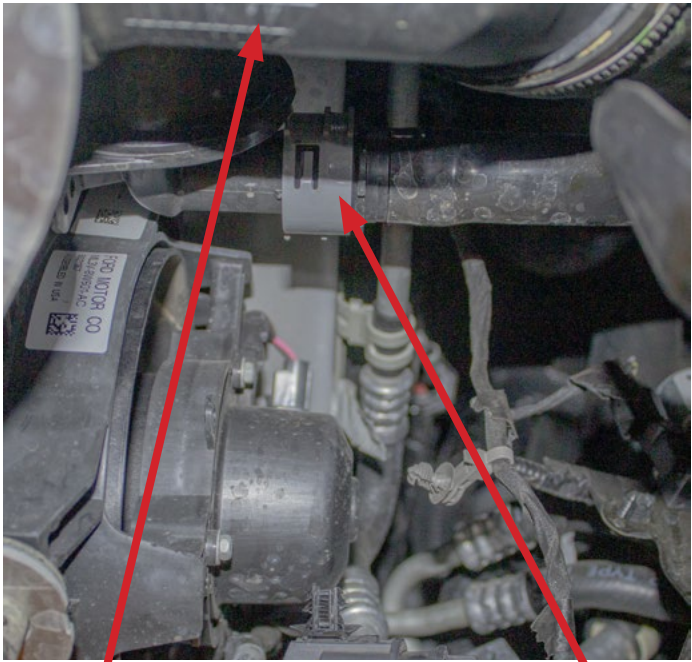
19. From underneath the truck, remove the intercooler fan connector. "Fig S"



**Disconnect connector**

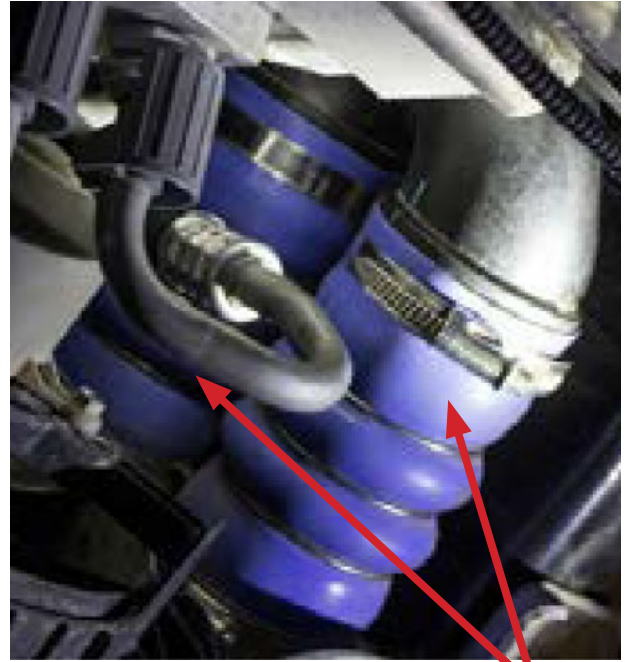
**Fig S**

20. Undo the clip for the driver side intercooler pipe and move it out of the way. Then, pull that pipe from the intercooler. Remove the recirculation tube from the recirculation valve. Using a 7mm Socket, loosen the clamps on both blue boots on the passenger side of the vehicle. Then, pull the blue boots off the pipes they are connected to. "Fig T"



**Driver side pipe**

**Recirculation tube**



**Remove blue boots**

**Fig T**

21. Using a 13mm Socket, remove the two mounting bolts for the intercooler/fan support. Then, remove this support along with the intercooler/fans. "Fig U"



**Fig U**



22. Follow the driver side intercooler pipe up until you see a black boot. Use a 7mm Socket to loosen the farther of the two hose clamps. Then, remove the end-pipe/boot assembly from the pipe they are connected to. "Fig V"



**Fig V**

23. Under the hood of the truck, unplug the PCV line that is connected to the charge pipe coming off the throttle body. "Fig W"



**Fig W**

24. Unplug the MAP sensor connector on the tube coming off your throttle body. Also, remove the plastic clip holding the sensor harness to this same pipe. "Fig X"



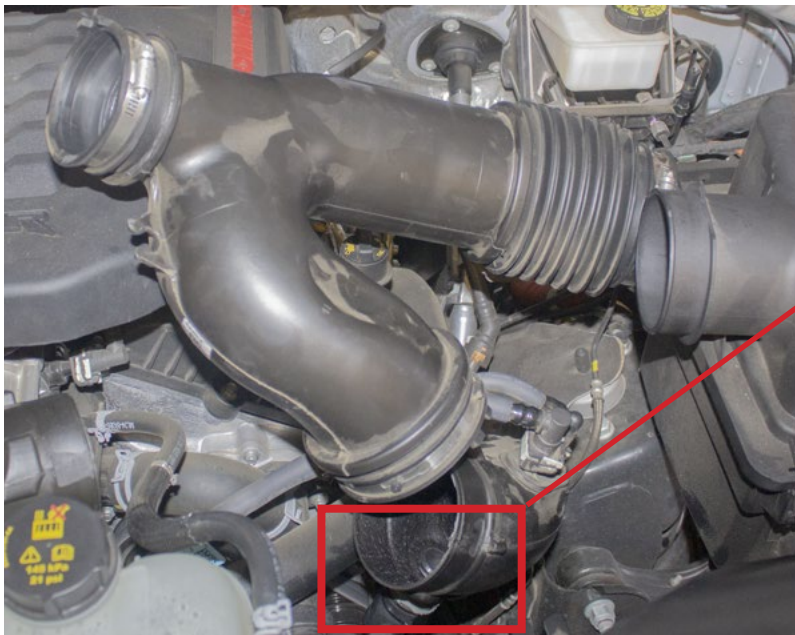
**Fig X**

25. Use a 7mm Socket to loosen the hose clamps for the charge pipe coming off the throttle body. Then, remove this pipe from your vehicle. "Fig Y"



**Fig Y**

26. find the recirculation tube from Step 22 and follow it up until it meets your intake pipe. Remove this tube by cutting with a razor blade. (It will help to take off the intake Y pipe to get to this pipe) After the pipe has been removed, use the supplied cap then zip tie in place. After the cap has been installed reconnect the intake pipes. "Fig Z"



**Disconnect the pipe that goes down to the intercooler**

**After the pipe has been disconnected install the cap and zip tie in place**



**Fig Z**



27. Use an 8mm Socket to remove the recirculation valve mounting bolt. Then, remove the recirculation valve from the OEM intercooler. "Fig AA"

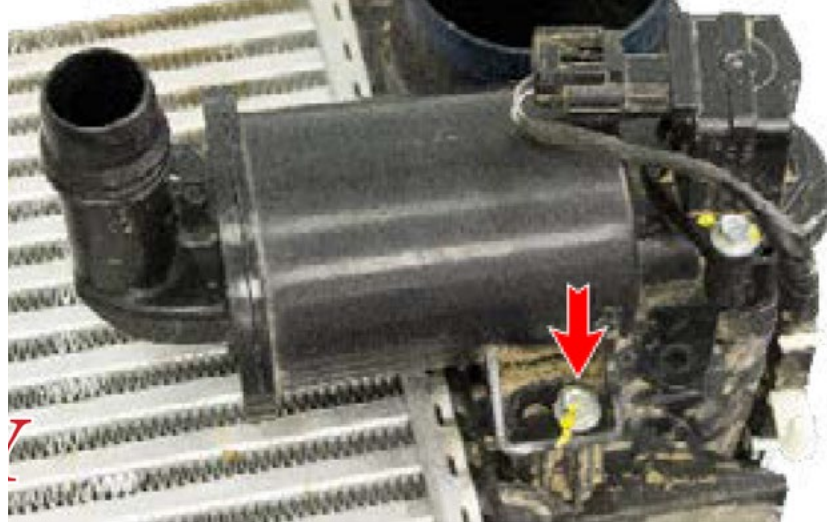


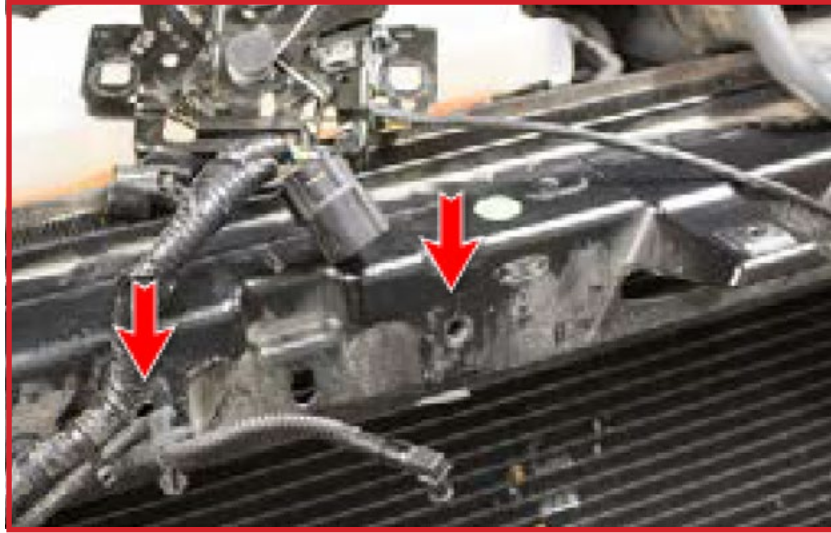
Fig AA

28. Find the pipe you removed in Step 24. Use a T27 Torx Bit to remove the MAP sensor mounting bolt. Then, remove the MAP sensor from that pipe. "Fig AB"



Fig AB

29. Use a 10mm Socket to remove the two hood latch mounting bolts. "Fig AC"



**Fig AC**

30. Use a 3mm Allen Socket to install the recirculation valve on the new intercooler piping with the supplied M4 Bolt (x1) and Washer (x1). "Fig AD"



**Fig AD**

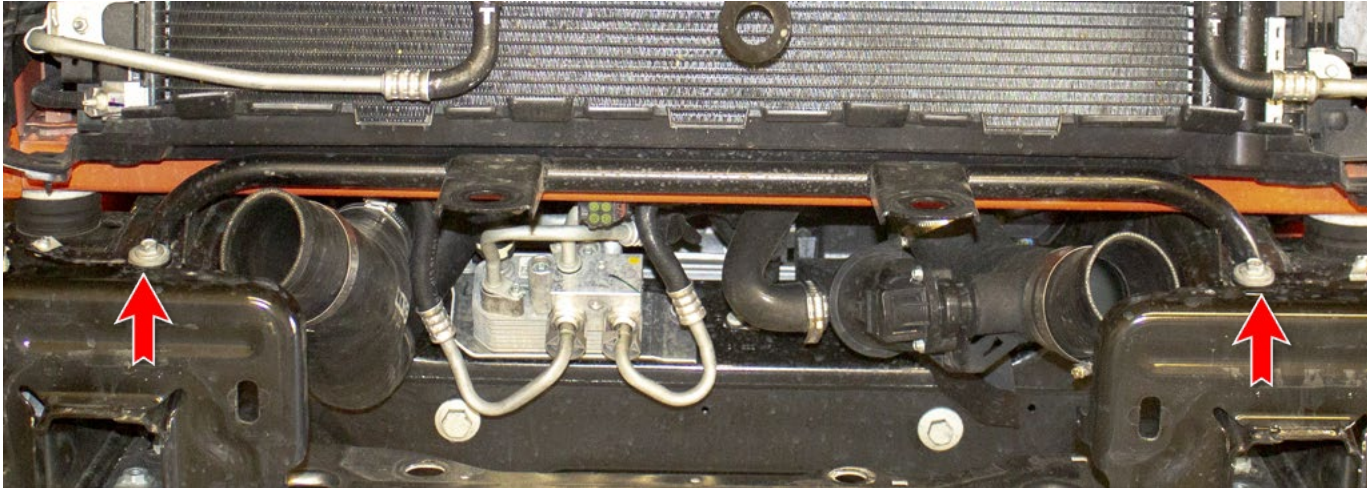
31. Use a 5mm Allen Socket to install your MAP sensor on your new intercooler pipe using the supplied M6 Bolt (x1). "Fig AE"



**Fig AE**

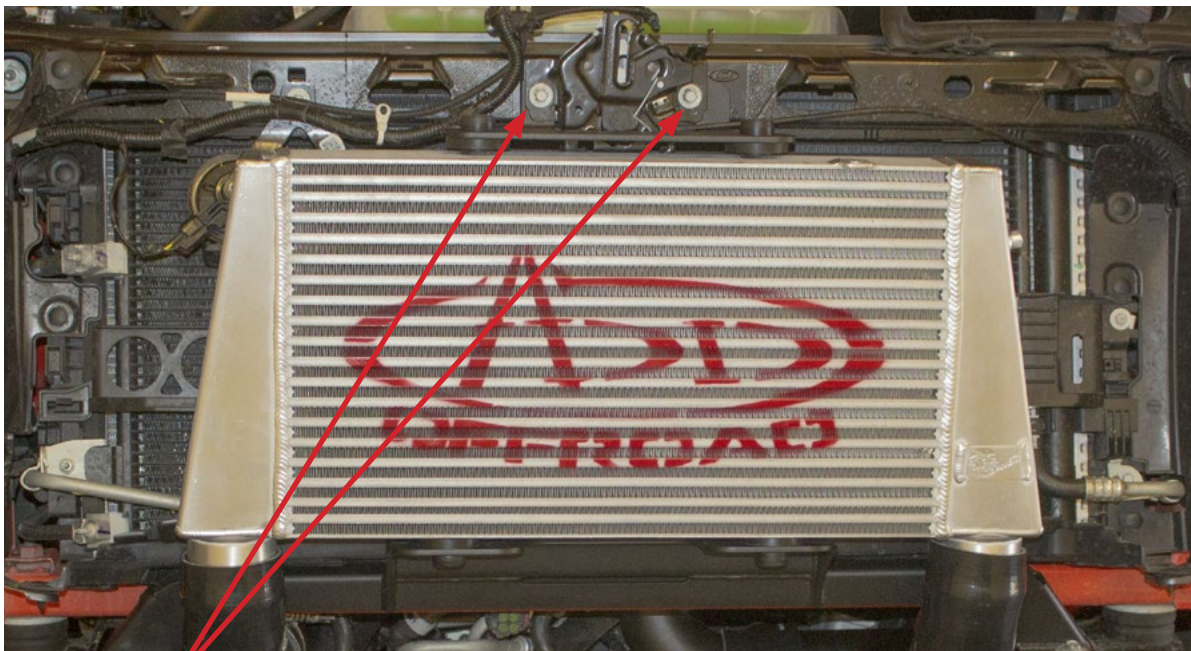


32. Using a 13mm Socket and the OEM bolts you removed in Step 18, install the supplied lower intercooler support. "Fig AF"



**Fig AF**

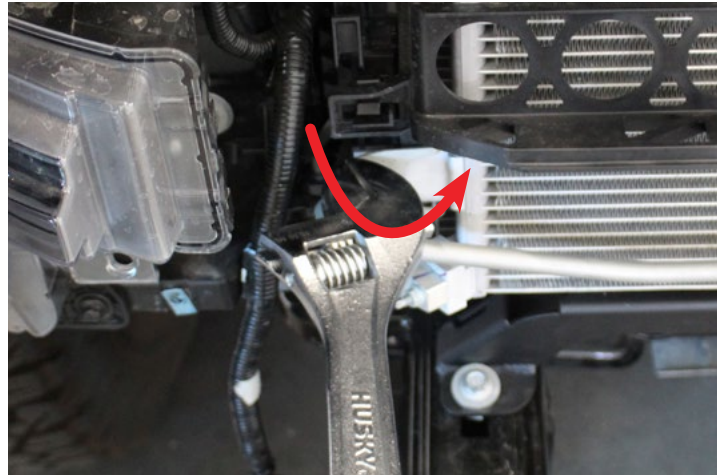
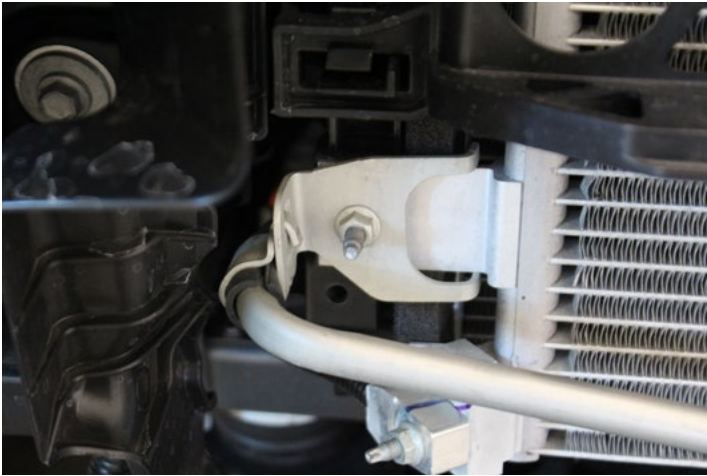
33. Set the new intercooler in place, so that the rubber feet sit in the openings of the lower support. Then, bolt the upper support in place. Use a 10mm Socket and the OEM hardware you removed in Step 29. Make sure to mount the upper intercooler support on the outside of the hood latch. You will have to trim the plastic lip of the trans cooler behind the intercooler. Try to set the intercooler in place first so you can gauge how much of the lip will need to be trimmed. "Fig AG"



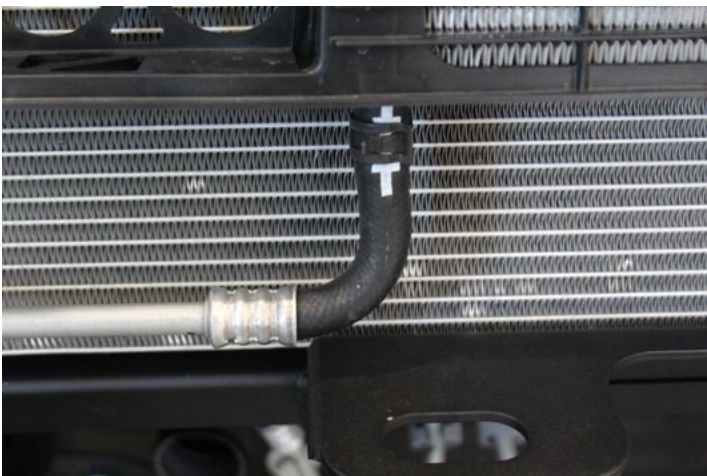
**Use OEM hardware**

**Fig AG**

34. Using a crescent wrench, bend the cooling line located on the passenger side in as shown below.



35. Next, use a pair of pliers to move the hose clamp in to avoid the innercooler hitting against it.





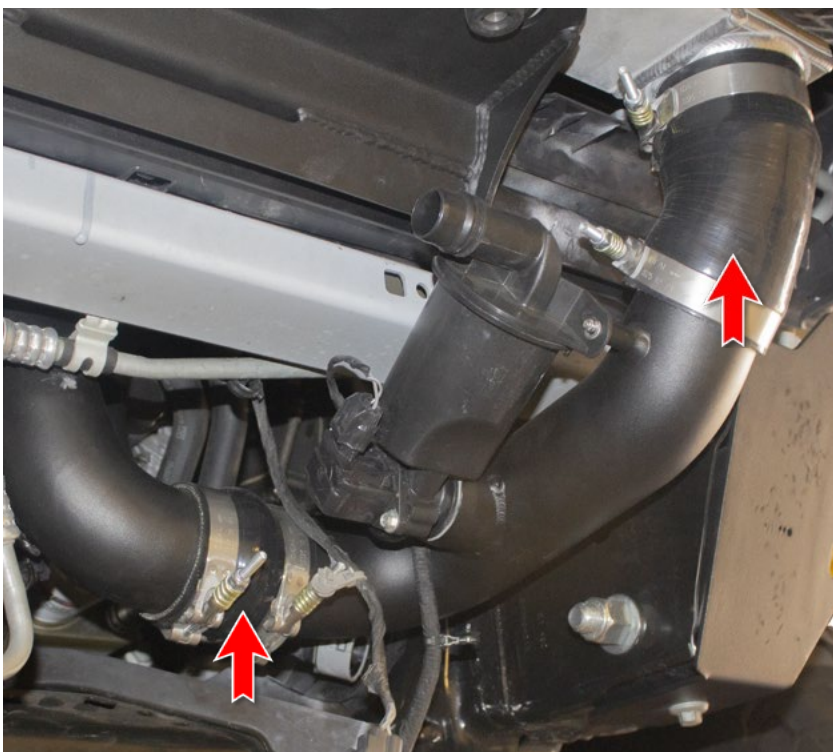
36. Connect your upper charge pipe (with the MAP sensor bolted to it) to your throttle body using one of the supplied straight boots with two of the supplied hose clamps. Leave the hose clamps loose for now. "Fig AH"



**Fig AH**

37. Plug in the MAP sensor connector and reconnect the PCV line you removed in Steps 25 & 26

38. From underneath the vehicle, install your driver side charge pipe (with the recirculation valve connected to it). One end of this pipe connects to the bottom of the pipe you installed in Step 34, while the other end of this pipe connects to your new intercooler. Use one of the angled rubber boots on the intercooler connection. Use the straight boot with the bulge in it for the pipe/pipe connection. Use four of the supplied hose clamps. Once all of the boots and hose clamps are installed, use an 11mm socket to tighten the clamps you installed in this step as well as the clamps that were installed in Step 34. **(Make sure the boot is all the way up on the intercooler, if it hangs down to low it the bumper wont fit right.)** "Fig AI"



**Fig AI**

39. Install the passenger side charge pipe. Use the two smaller boots, one angled boot, and six hose clamps. Once all of the hose clamps are loosely installed, go back and tighten them all with an 11mm socket. **(Make sure the boot is all the way up on the intercooler, if it hangs down to low it the bumper wont fit right.)**"Fig AJ"

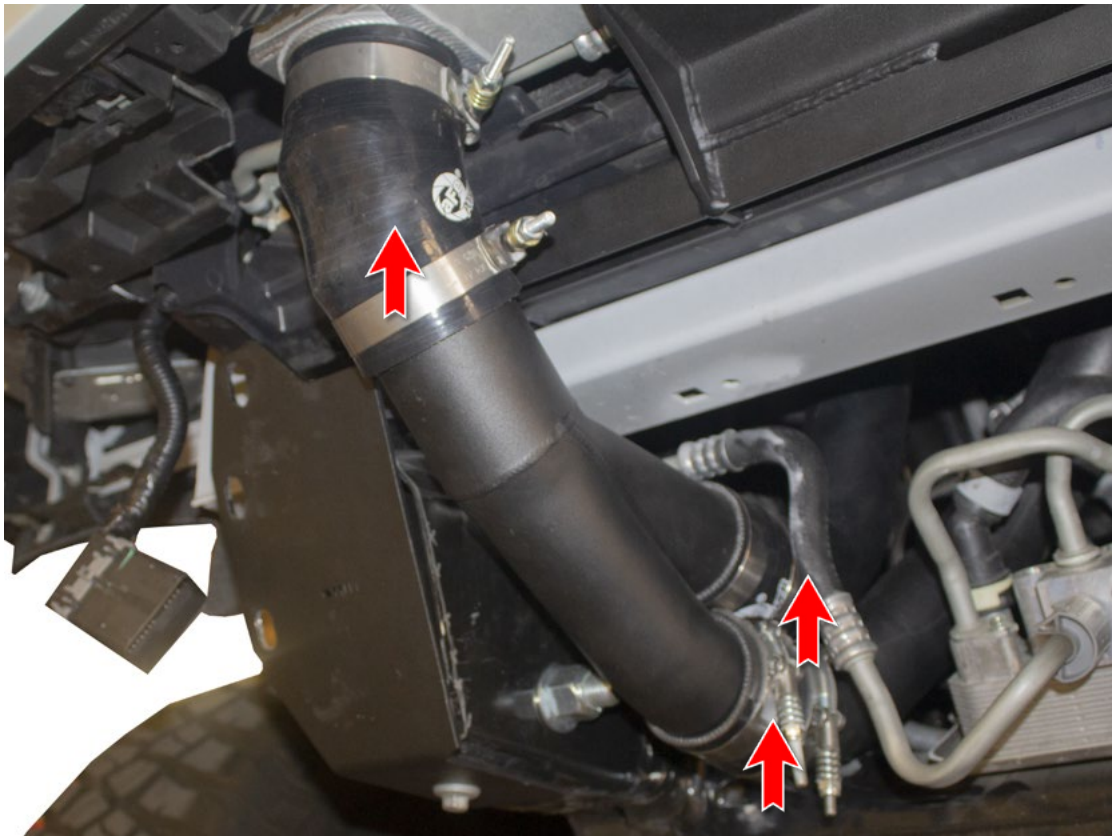
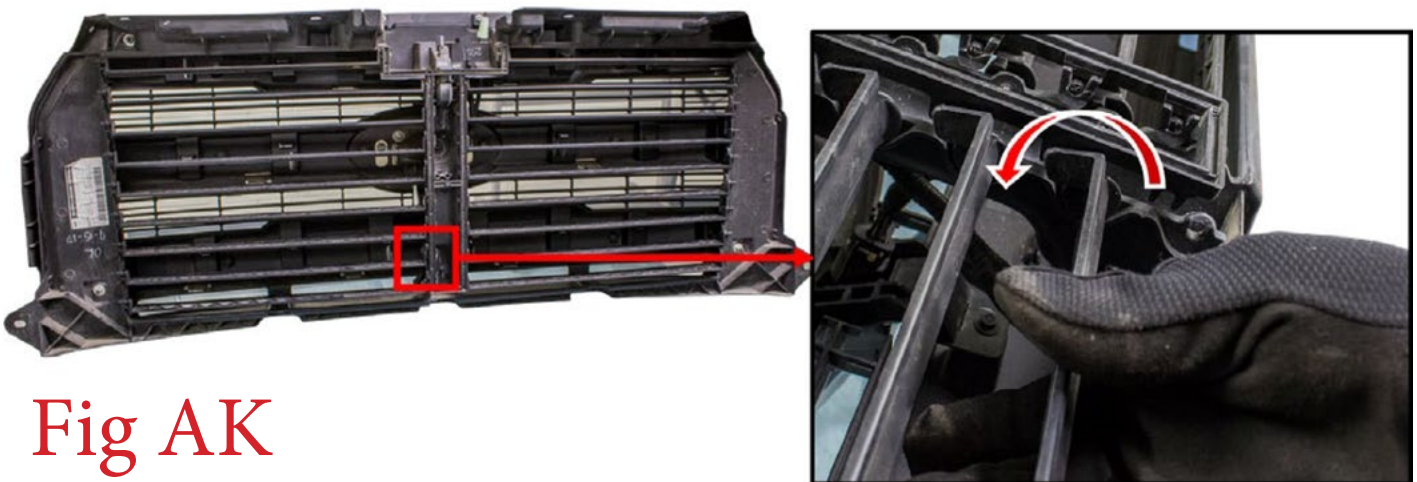
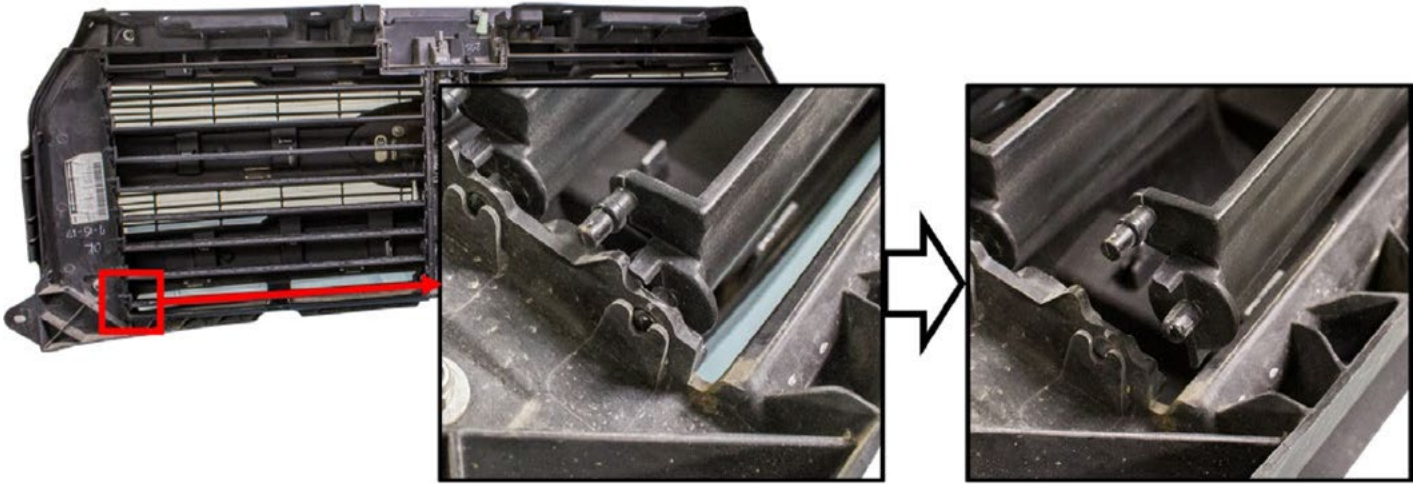


Fig AJ

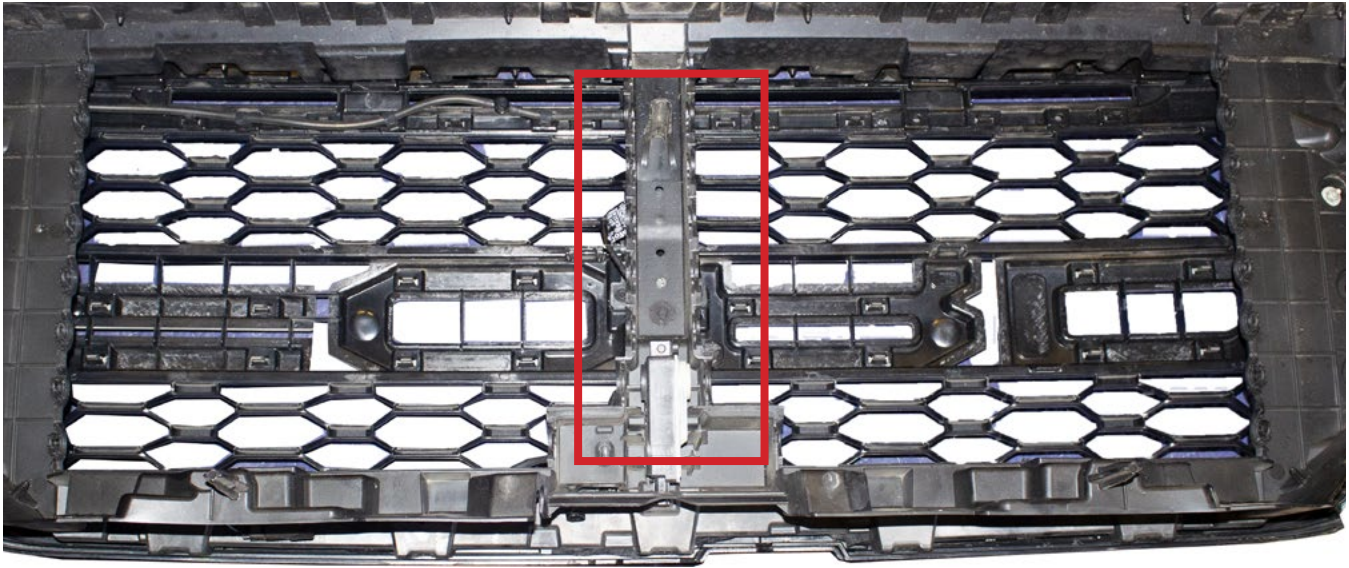


40. Remove all grille shutters from the back side of the grille. To do this, remove the outer from its hole by bending the middle portion of the shutter outwards until there is enough clearance to release the peg. Then, rotate the shutter towards the front of the grille to release the inner pegs. After the shutters have been taken out remove the shutter motor out of the grill to relocate."Fig AK"



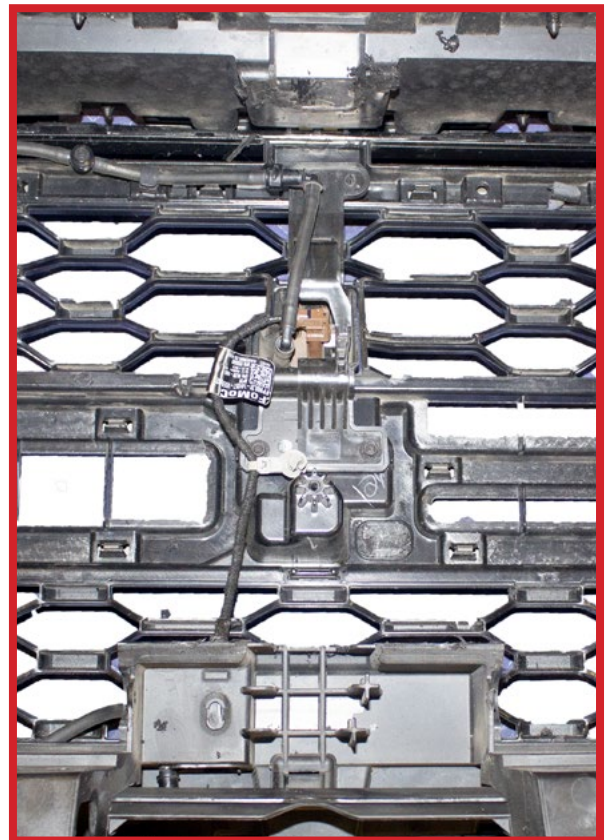
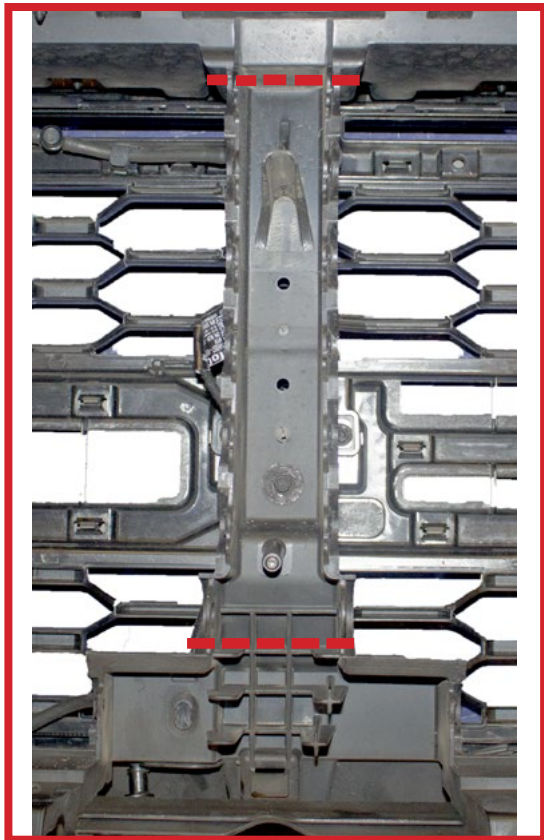
**Fig AK**

41. After the fins and shutter motor have been taken out the grille, the center section of the grille will need to be cut out to make room for the intercooler. This is a 2 step guide to cutting this center section. Cut the center section as shown below in Fig "AL" (be sure not to cut any lines that may be in the way.)



**Before Cut**

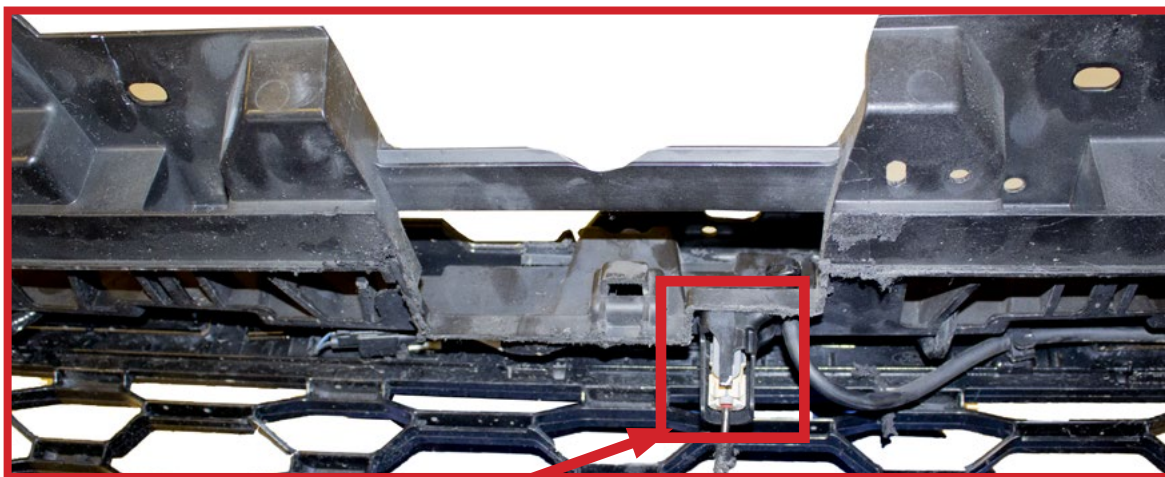
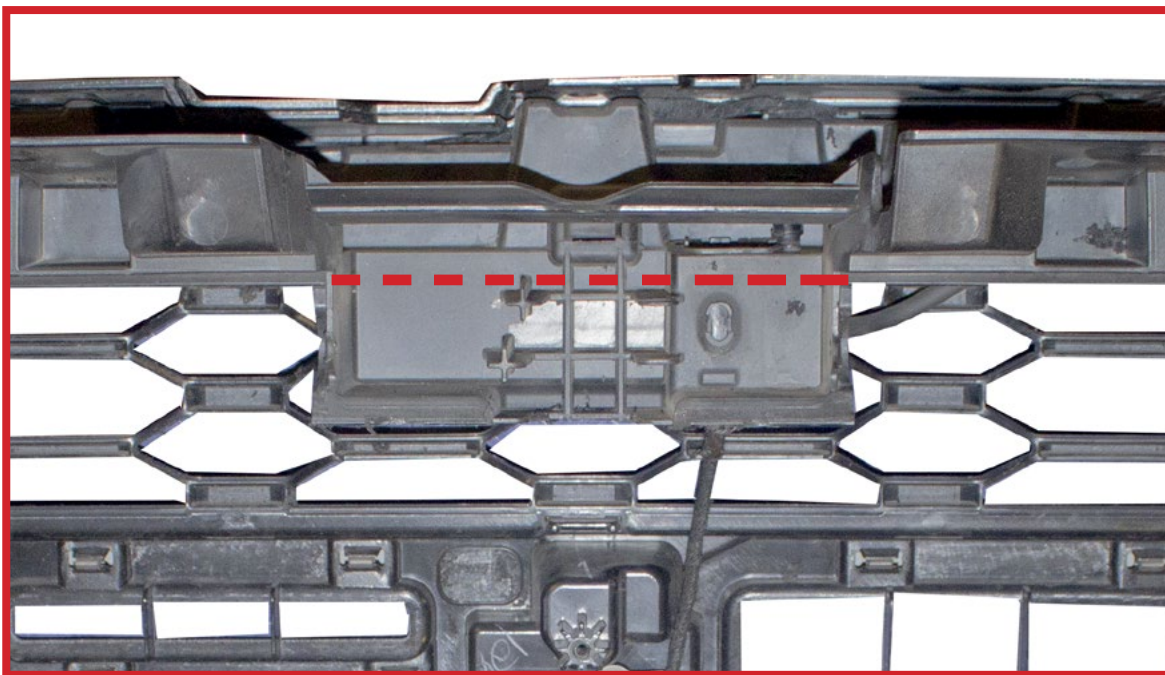
**After Cut**



**Fig AL**



42. After the center section has been cut, there is still some plastic that will also have to be cut down. Shown below is the area that needs to get cut flush with the top of the grille. Once that has been done you can now install the grille once the intercooler is in place. "Fig AM"

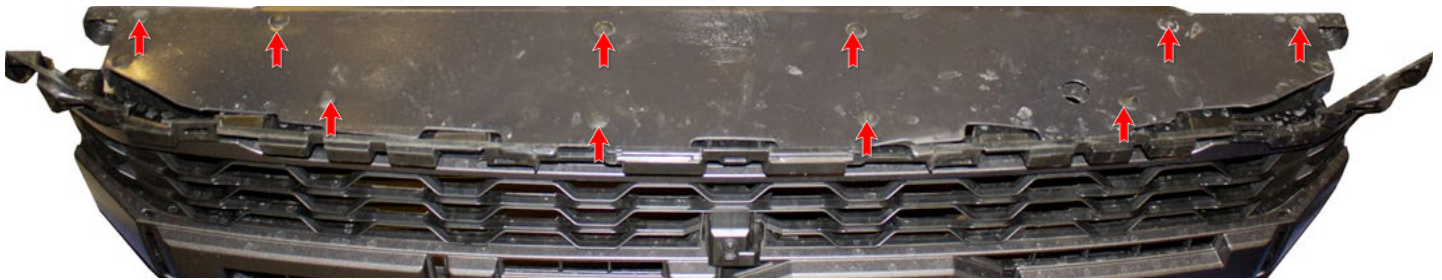


**Be sure to not to cut the line that runs up to the top of the grille**

**Fig AM**

43. On the bottom of your grille after taking the plastic cover off, Mark a line from the middle of the grille that measures out 4 1/2" inches from that line on each side mark out 15.8" when you add both sides together you should get 31 5/8" total length. After the grille has been cut you can re-install it and connect all the connectors. "Fig AN" (Follow the cutting guide below)

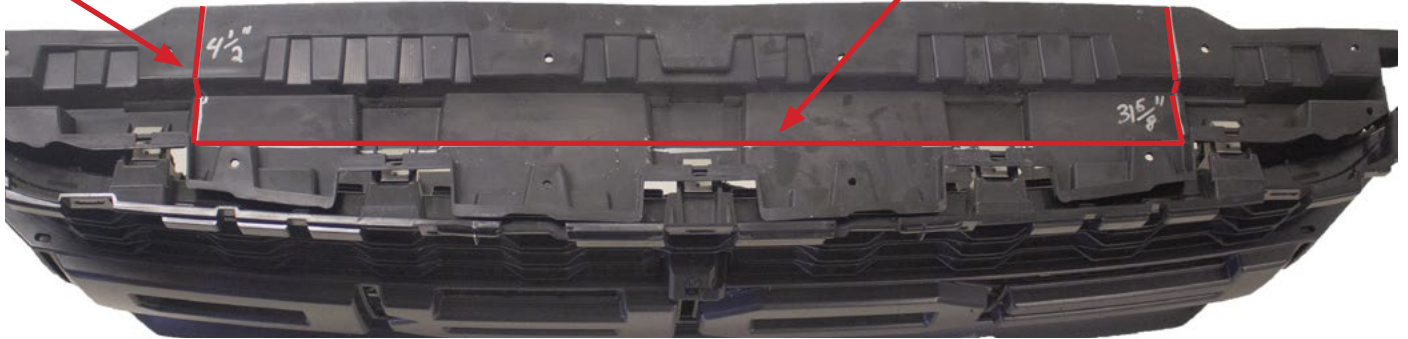
**Pop out the plastic clips holding in place the plastic cover**



**Measure 4 1/2"**

**Before cut**

**Measure 31 5/8" Across**



**After cut**

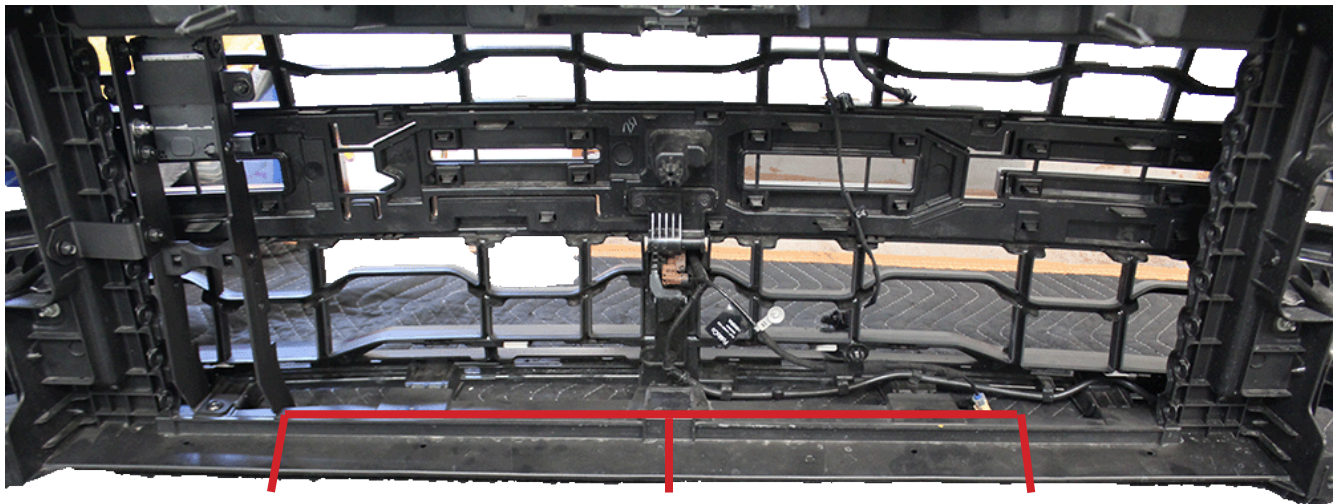
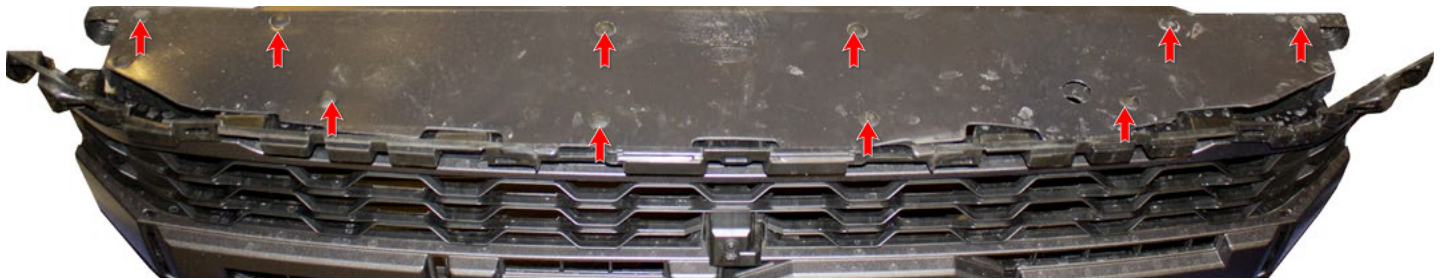


**Fig AN**



44. On the bottom of your grille after taking the plastic cover off, Mark a line from the middle of the grille then measure out 14 1/2" inches than from that line when you add both sides together you should get 29" total length. After the grille has been cut you can re-install it and connect all the connectors. Miter cut the corners as shown in last picture

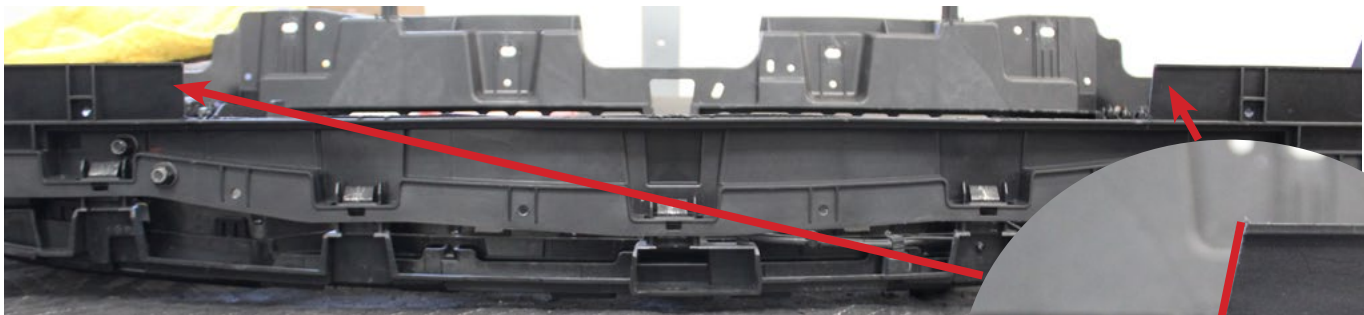
**Pop out the plastic clips holding in place the plastic cover**



14 1/2"

Measure from center

14 1/2"

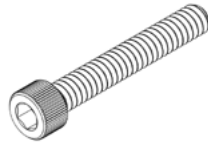


## SHUTTER MOTOR RELOCATION KIT INSTALL GUIDE

AC1300900NA

### HARDWARE/PARTS

**A.**



10-24 X 1.25 SOCKET HEAD SCREW

**QTY: 1**

**A1.**



10-24 NYLON WASHER

**QTY: 4**

**A2.**



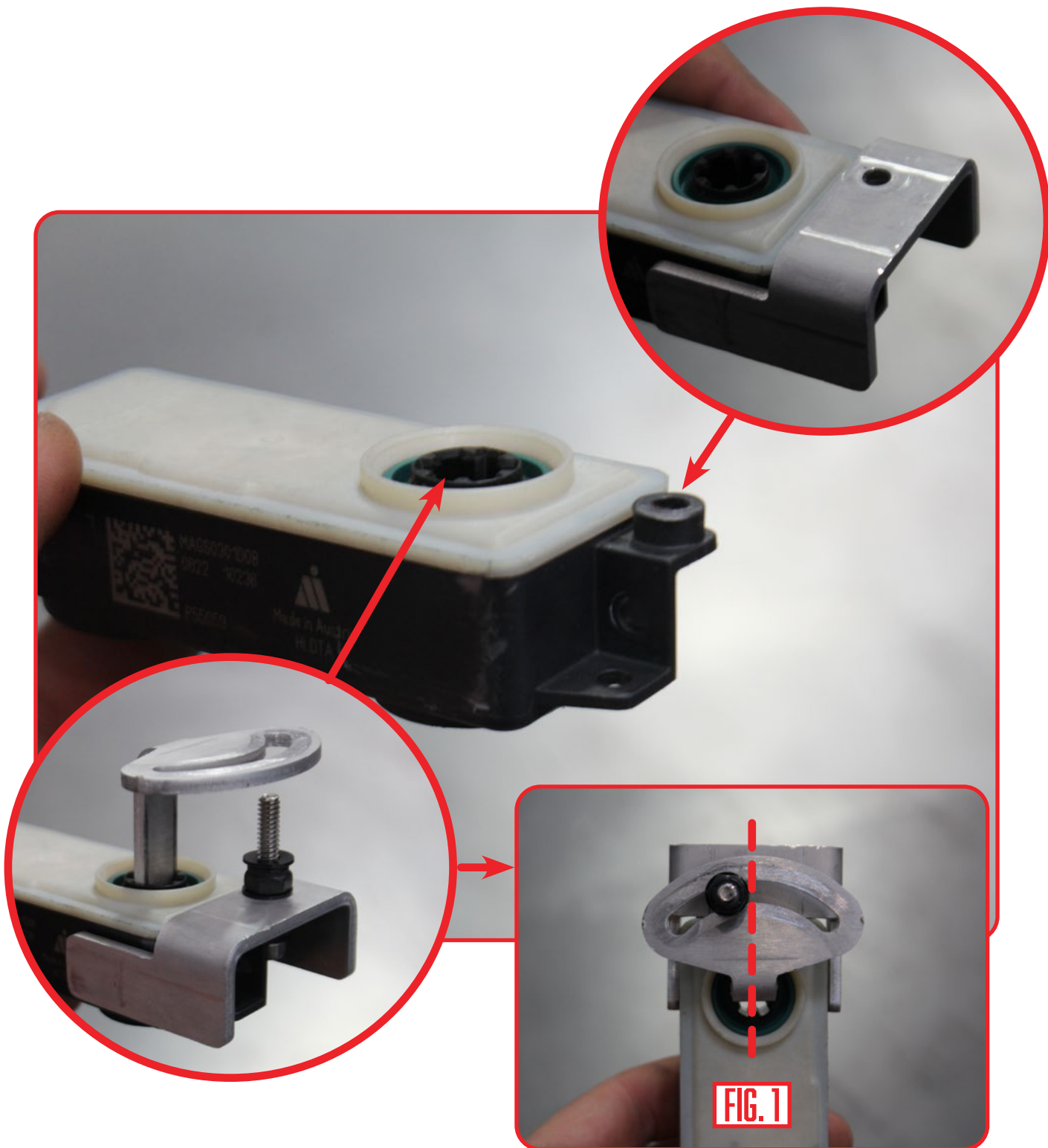
10-24 NYLON LOCK NUT

**QTY: 2**

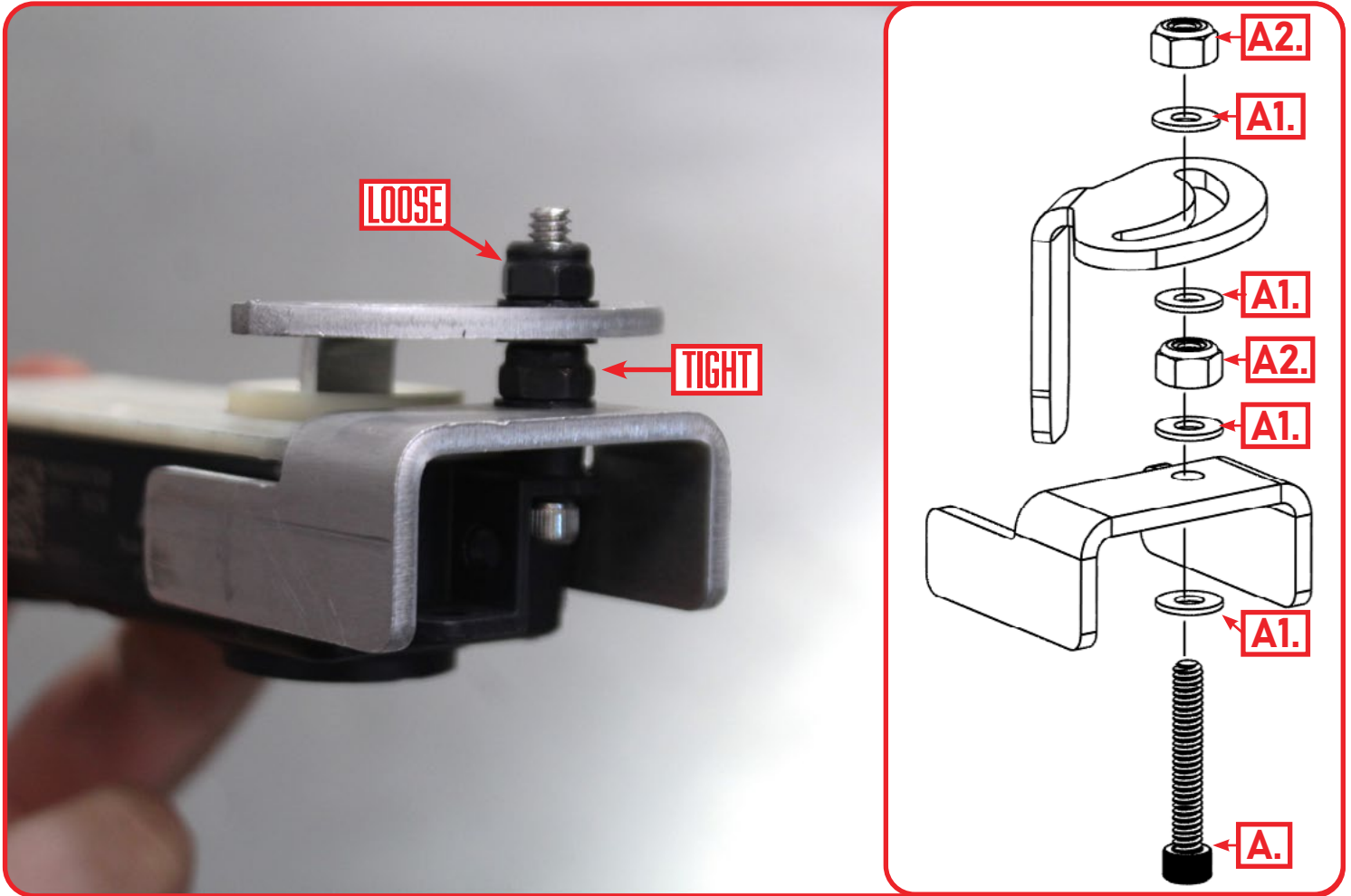
Reference this page throughout the install



45. Install the brackets as shown below. Be sure to install the top bracket center with the bottom bracket as shown in **FIG. 1**.



46. Using a (HW4 allen) and a (3/8 wrench), install the shutter motor relocation brackets in the order shown below. **\*\*Leave the top nylon lock nut loose enough for the bracket to move freely\*\***



47. Next, Plug in the shutter motor bracket and ziptie out of the way.



48. After the grille has been installed back on the raptor you can install the ADD bumper
49. Stand back and enjoy your new ADD Intercooler™ .
50. Check and re-tighten, if needed, all mounting bolts after 100 miles and periodically thereafter.

