

## 21-24/DODGE TRX BED SIDE SIDE MOLLE DRIVER AC6201901NA-D

AC6203801NA

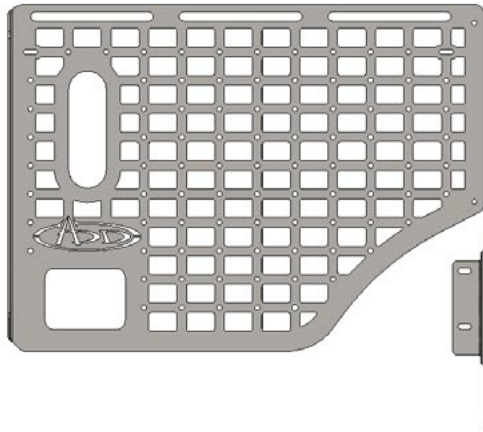

AC6205001NA

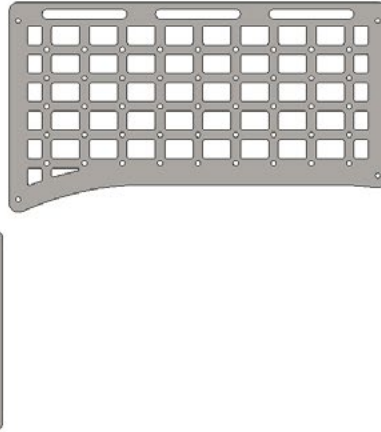

AC6203901NA

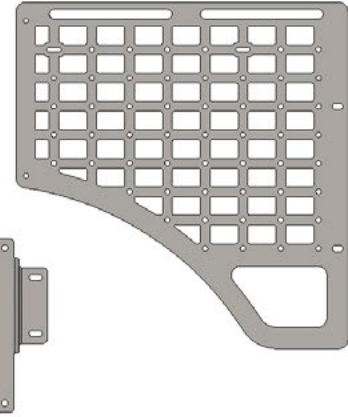

### TOOLS REQUIRED

- (Allen) 5/32
- (Wrench) 7/16
- (Socket) 10mm
- (Drill Bit) 25/64
- Ratchet
- Rivet Nut Hand Tool



### SKILL LEVEL

-Easy/Intermediate



### TIME REQUIRED

- 1 hours for OEM Removal/Install



### INCLUDED IN KIT

- 10- 1/4-20 X 3/4" Button Head Bolt
- 13- 1/4" Flat Washer
- 2- 1/4-20" Nylon Lock Nut
- 1- 1/4-20 X 1" Button Head Bolt
- 1- 1/4" Spacer
- 1- 1/4" Push Nut
- 5- 1/4-20" Rivet Nuts

## ⚠️ WARNINGS/CAUTIONS BEFORE STARTING INSTALLATION ⚠️

#### -BEFORE YOU INSTALL THIS KIT-

Read and understand all instructions, warnings, cautions, & notes contained in this installation instruction guide. Consult your vehicle owner's manual for proper disconnection of electrical and lifting of vehicle if required for installation of this product.

This install may require some technical skills and knowledge of basic mechanical work. If you do not feel that you are capable of performing this install please take this product to a trained professional.

After reading this guide please contact us with any questions or concerns before installing product.  
Customer Service (480) 671-0820

Addictive desert designs is *not* responsible for any bodily injury or harm to you or your vehicle as a result of an improper install.

Proper installation of this kit required knowledge of the factory recommended procedures for removal and installation of original equipment components.

We recommend that the factory shop manual and any special tools needed to service your vehicle be on hand during the installation. Installation of this kit without proper knowledge of the factory recommended procedures may affect the performance of these components and the safety of the vehicle.

Inspect all contents of this package to make sure product is not damaged and all installation hardware has been included. If parts are missing from kit, please be prepared to provide the following information:

1. Name of purchase location
2. Bar Code on side of box
3. Date above bar code
4. Date inside box cover

**\*ALWAYS WEAR EYE PROTECTION WHEN OPERATING POWER TOOLS\***

## HARDWARE/PARTS

**A.**



1/4-20 X 3/4" BUTTON HEAD BOLT

QTY: 10

**A1.**



1/4" FLAT WASHER

QTY: 13

**A2.**

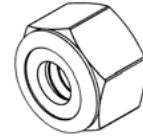

1/4-20" NYLON LOCK NUT BLACK

QTY: 2

**A3.**

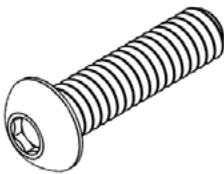

1/4-20 X 1" BUTTON HEAD BOLT

QTY: 1

**B.**

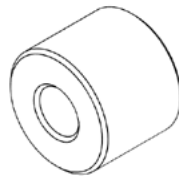

1/4" SPACER

QTY: 1

**C.**



1/4" PUSH NUT

QTY: 1

**D.**



1/4-20" RIVET NUT

QTY: 5

**Reference this page throughout the install**

## BED SIDE MOLLE DRIVER 21-24/DODGE TRX

## REMOVAL

### □ STEP 1

Using a (10mm) remove the 4x tie-down hook mounting brackets.

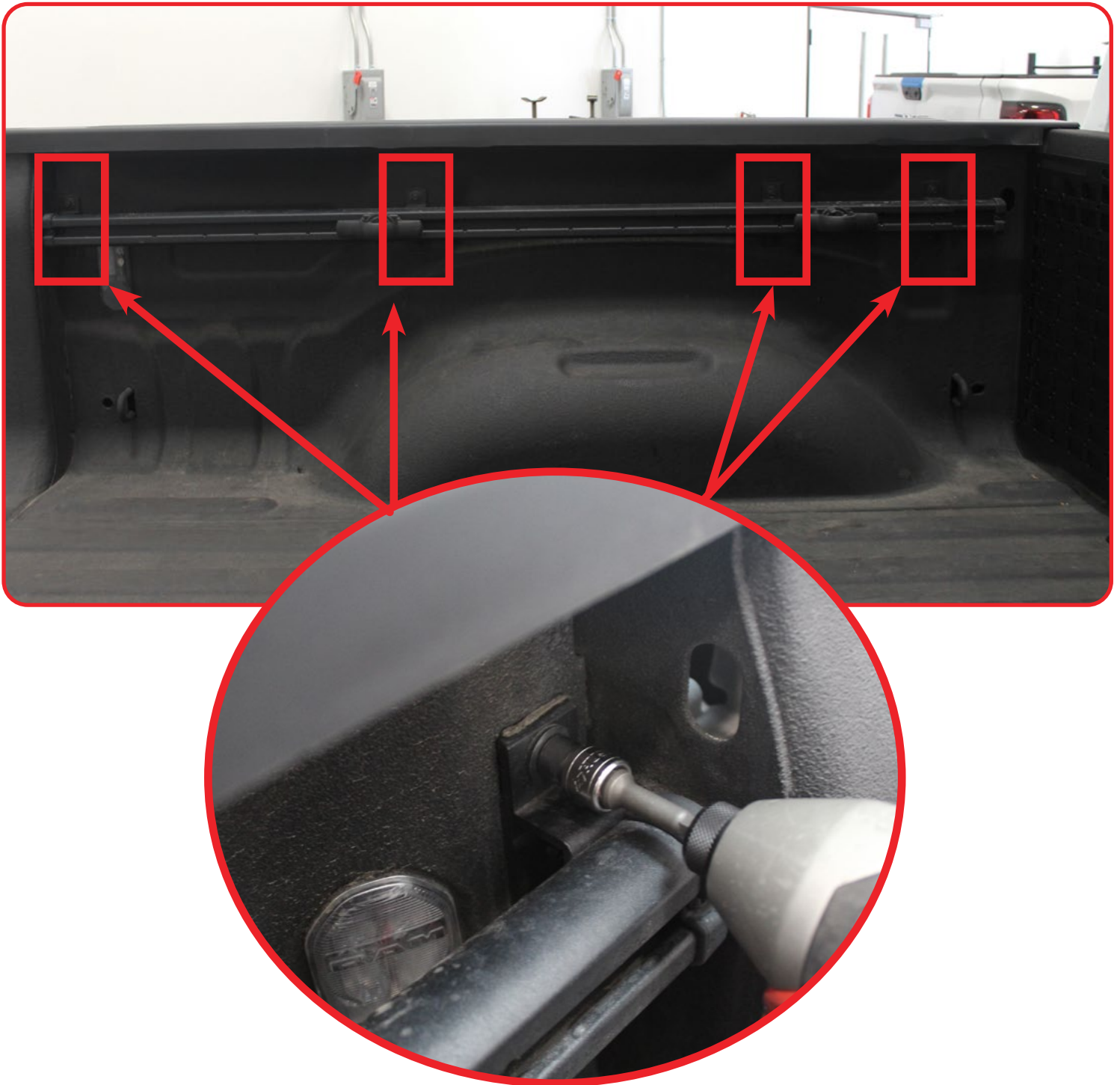

## BED SIDE MOLLE PASSENGER 21-24/DODGE TRX

## INSTALL

### □ STEP 2

Install the provided mounting brackets using the hardware removed from step 1.

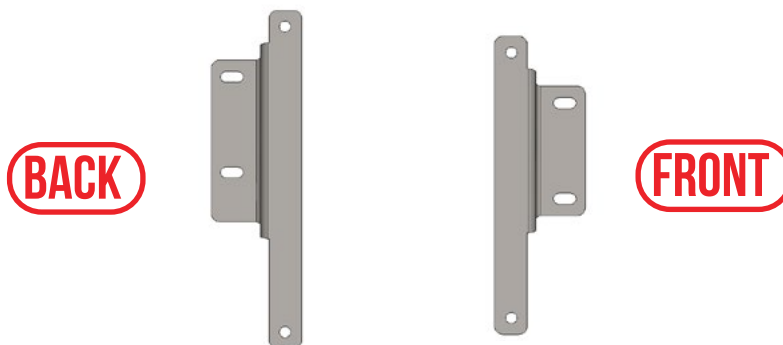

## BED SIDE MOLLE PASSENGER 21-24/DODGE TRX

## INSTALL

### □ STEP 3

Using a (5/32 allen) install the Driver Rear, Driver Center, and Driver Front molle panels with the provided **(A, A1)** 1/4-20 x 3/4 button head bolts, and washers.

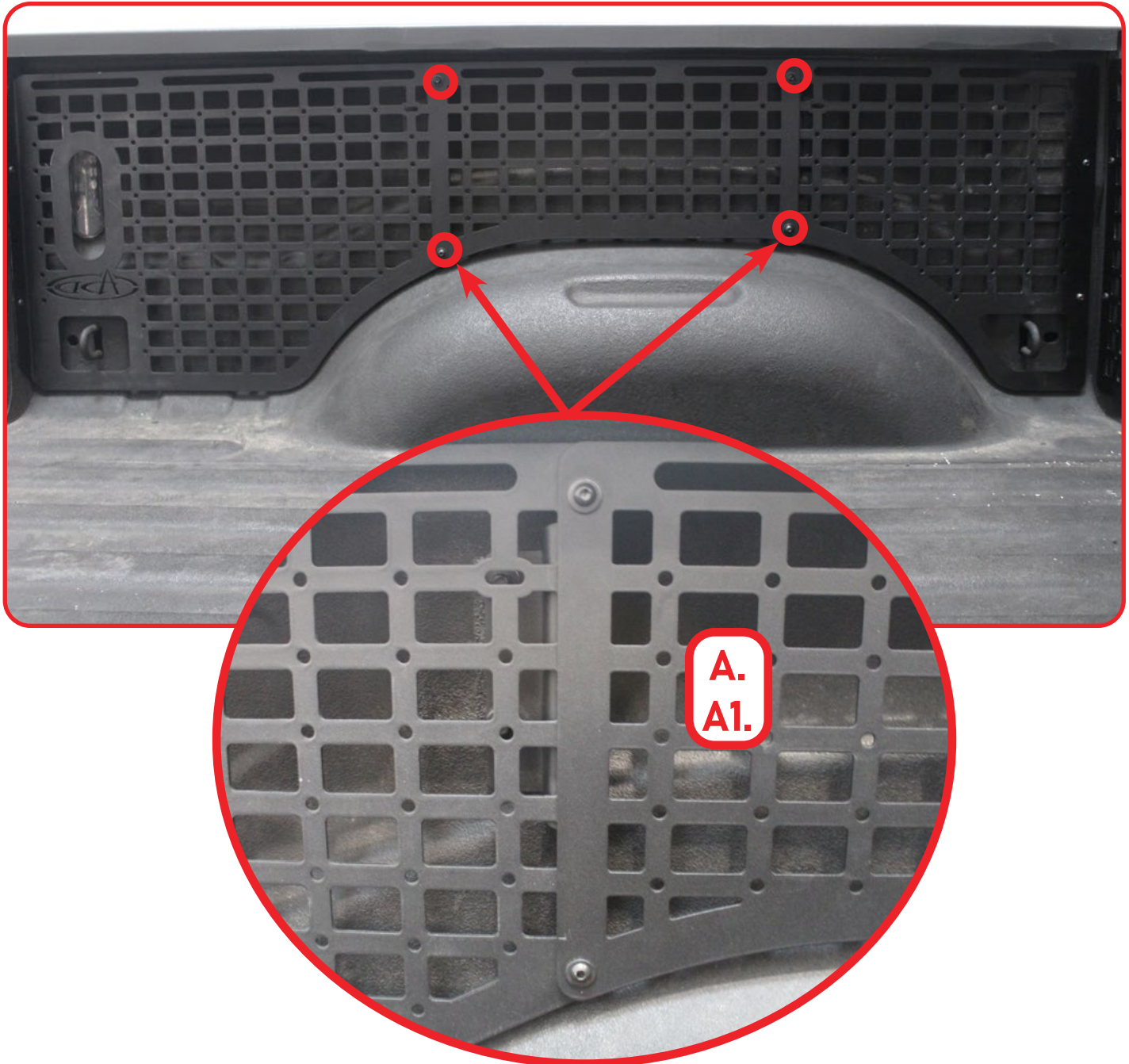

BED SIDE MOLLE DRIVER  
**21-24/DODGE TRX**

## INSTALL

**STEP 4**

Mark the driver front mounting holes.

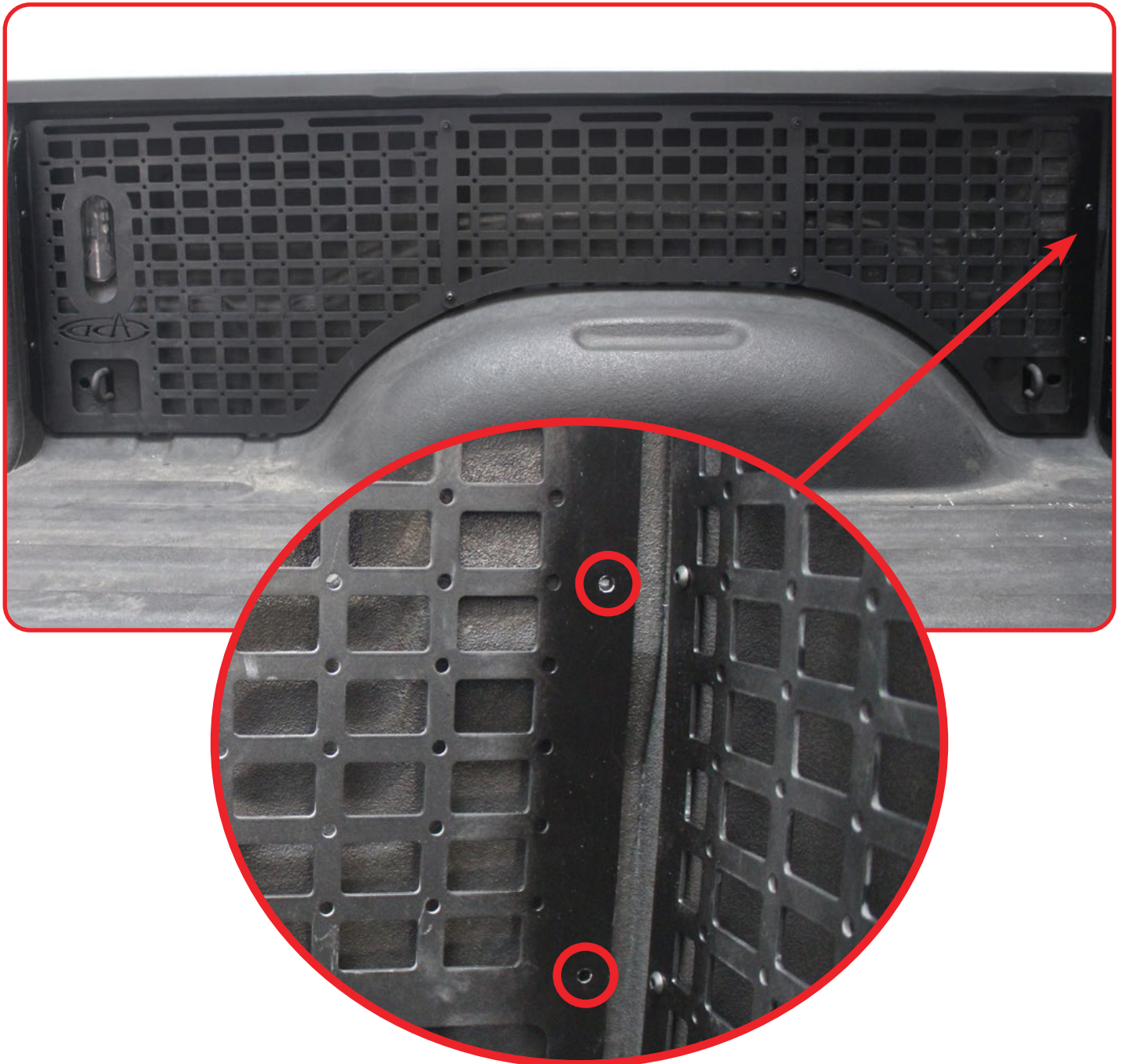

## BED SIDE MOLLE DRIVER 21-24/DODGE TRX

## INSTALL

### STEP 5

Mark the Driver Rear mounting holes.

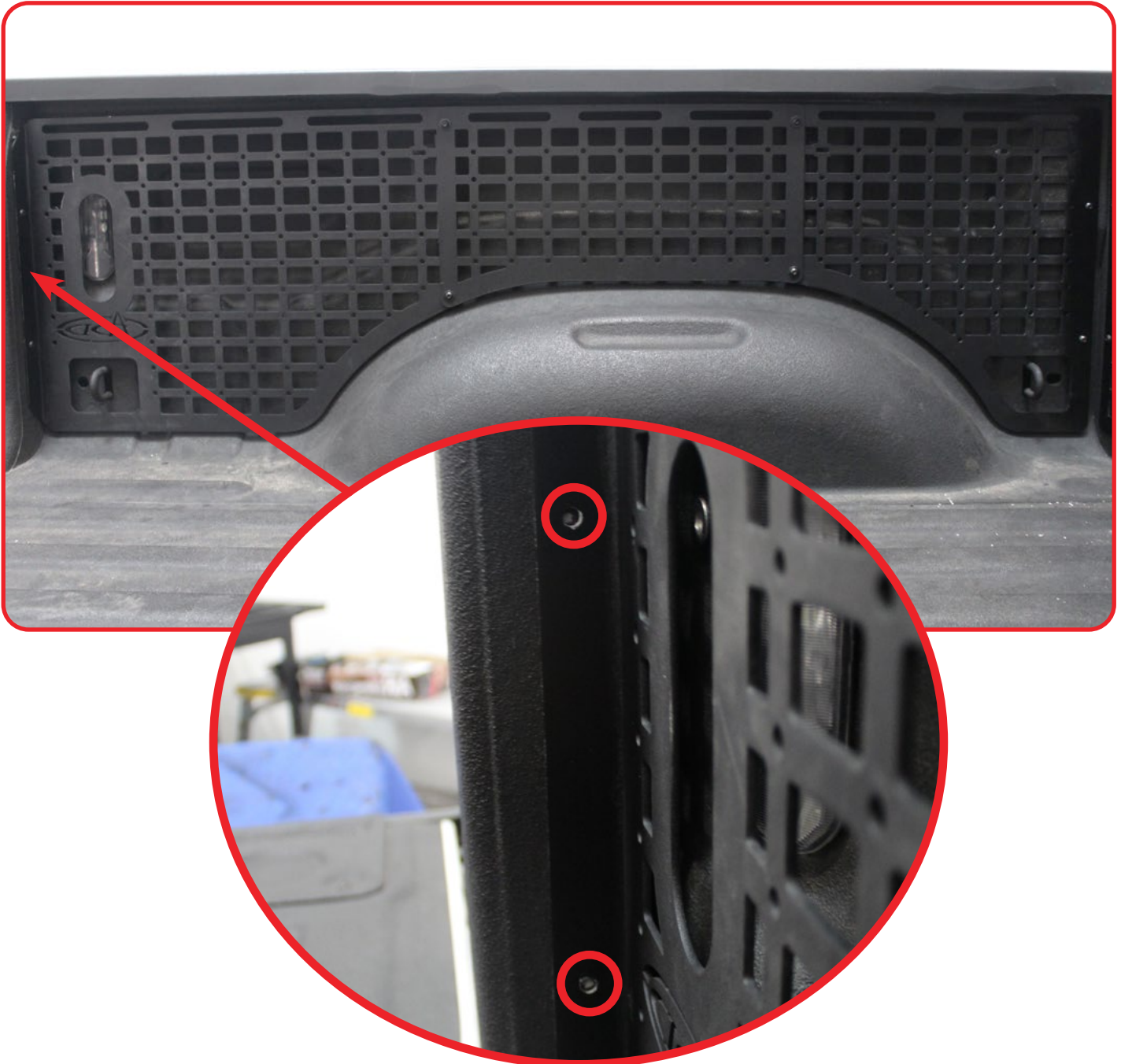

## BED SIDE MOLLE DRIVER 21-24/DODGE TRX

## INSTALL

### □ STEP 6

Mark the Driver Rear mounting hole located near the wheel well as shown below.

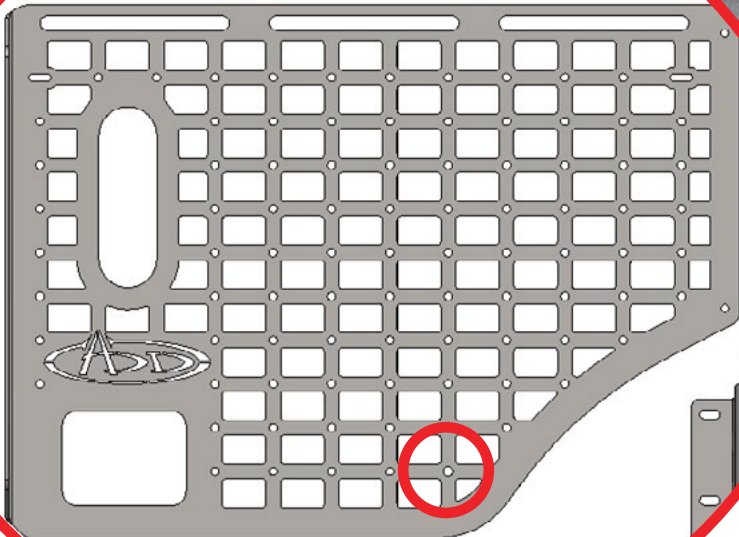
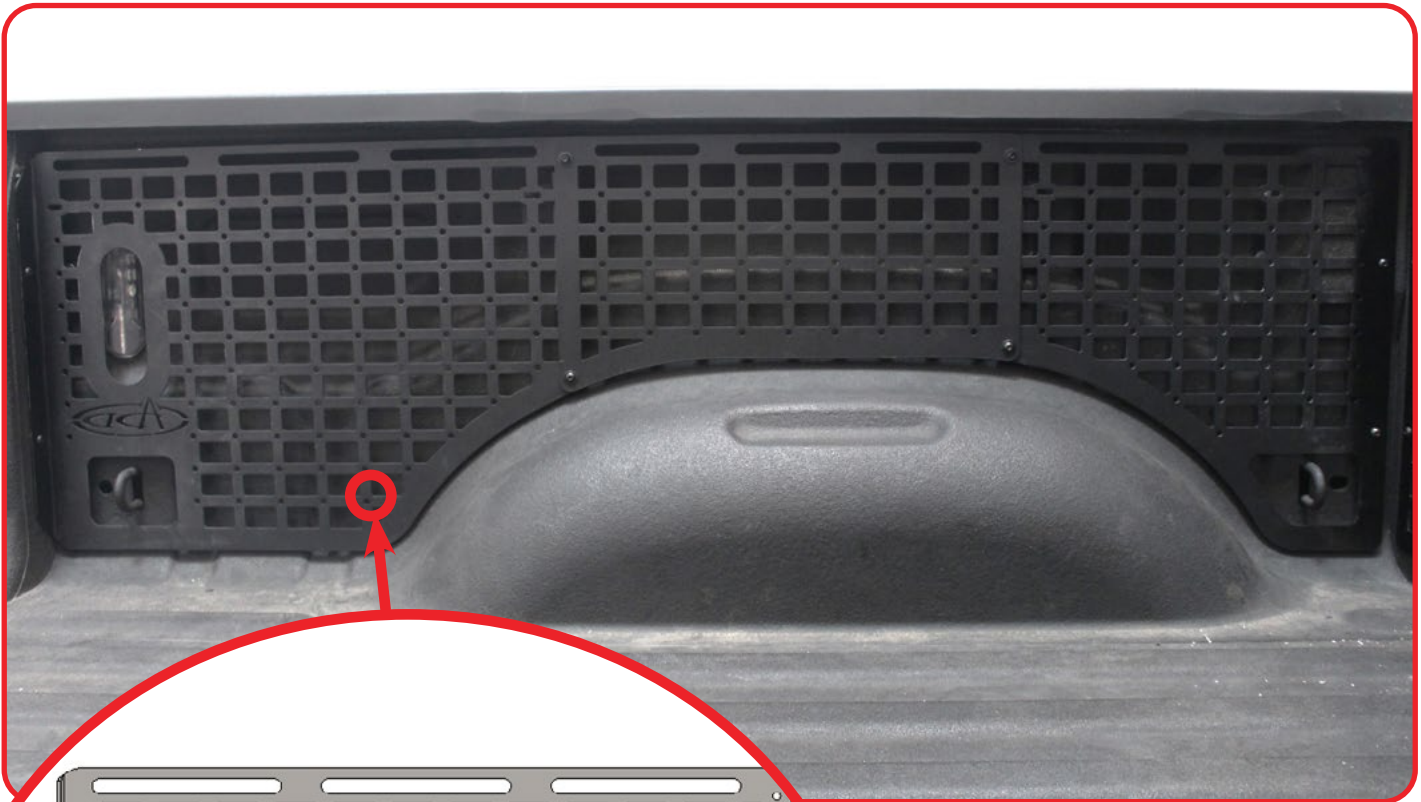

**MARK**





## BED SIDE MOLLE DRIVER 21-24/DODGE TRX

## INSTALL

### □ STEP 8

Using a (rivet nut tool) install the provided (D) 1/4-20 rivet nuts in the holes drill in step 7.

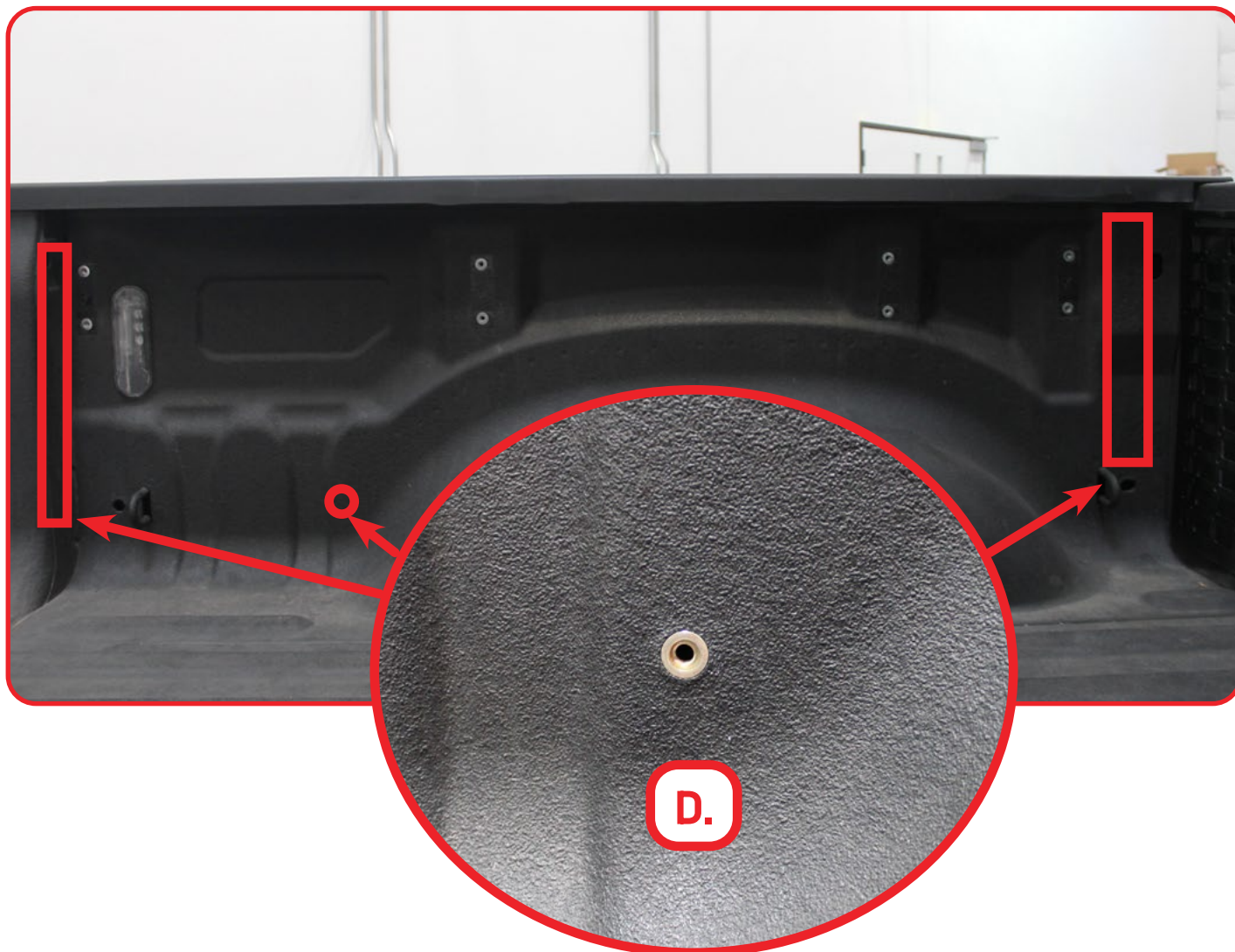

### TECH TIP

If you do not have a rivet nut tool, use a 1/4-20 x 3/4 hex head bolt, a 1/4 washer, and a 3/8 nut to install the rivet nuts. Tighten using a (9/16 wrench) and a (7/16 socket) on a impact.

**\*\*HARDWARE NOT INCLUDED\*\***

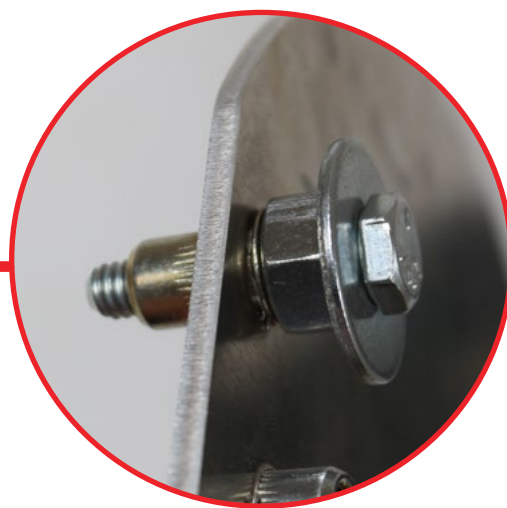

## BED SIDE MOLLE DRIVER 21-24/DODGE TRX

## INSTALL

### □ STEP 9

Before re-install, use the provided **(A1, A3, B, C)** 1/4-20 X 1" button head bolt, 1/4" washer, 1/4" spacer, and the 1/4" push nut. Install on the **back side** of the Driver Rear Molle Panel as shown below.

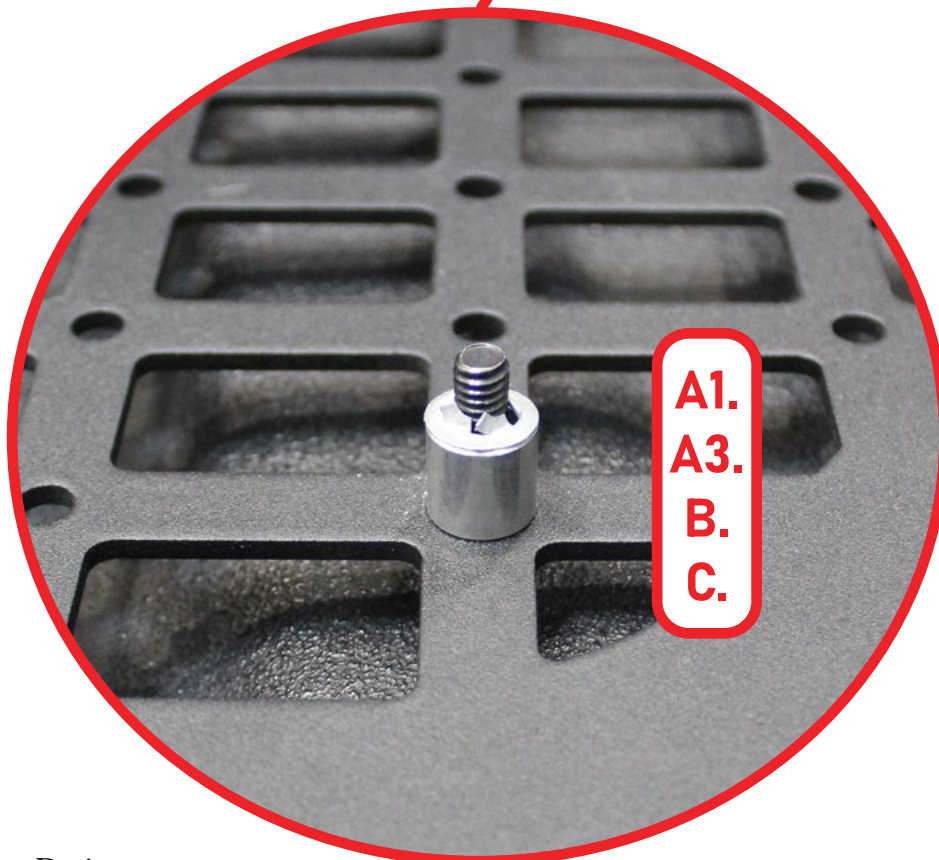
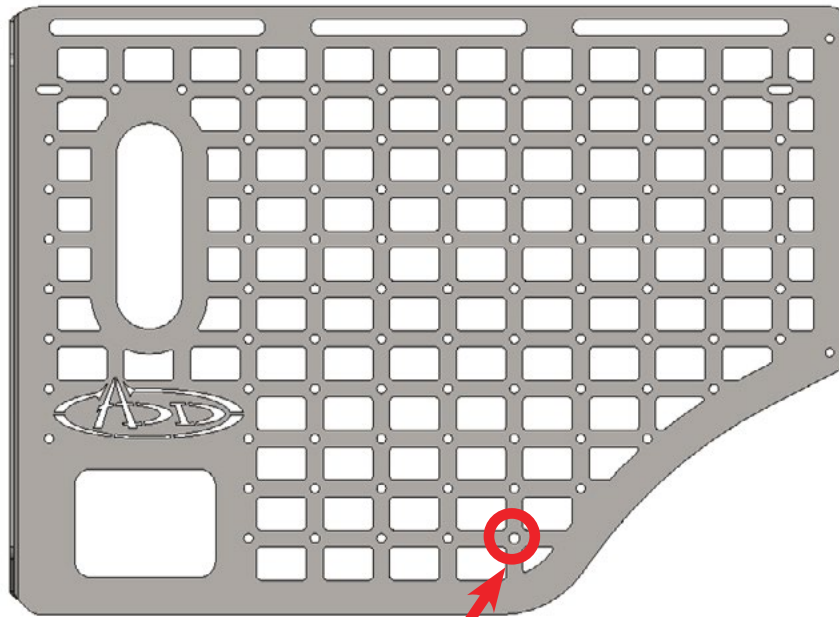

## BED SIDE MOLLE DRIVER 21-24/DODGE TRX

## INSTALL

### □ STEP 10

- Re-Install the Driver side molle panel by repeating **step 2**.
- Using a (5/32 allen), tighten down the **(A)** 1/4-20 X 3/4" button head bolt located on the Driver Rear Molle.



## BED SIDE MOLLE DRIVER 21-24/DODGE TRX

## INSTALL

### STEP 11

Using a (5/32 allen), install the provided **(A, A1)** 1/4-20 X 3/4" button head bolts, and washers located on the Driver Rear Molle as shown below.

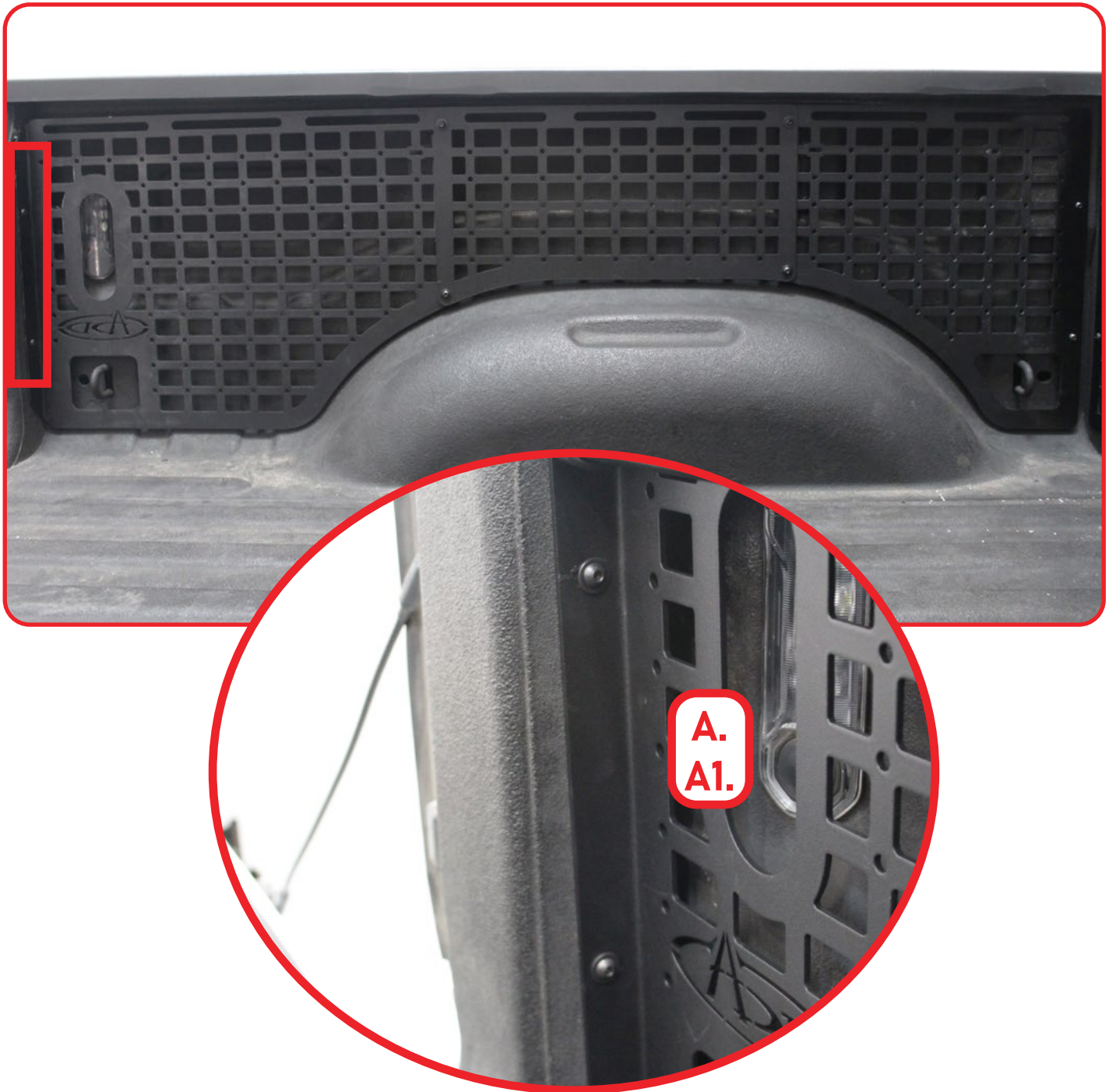

## BED SIDE MOLLE DRIVER 21-24/DODGE TRX

## INSTALL

### □ STEP 12

Using a (5/32 allen), install the provided **(A, A1)** 1/4-20 X 3/4" button head bolts, and washers located on the Driver Front Molle as shown below.

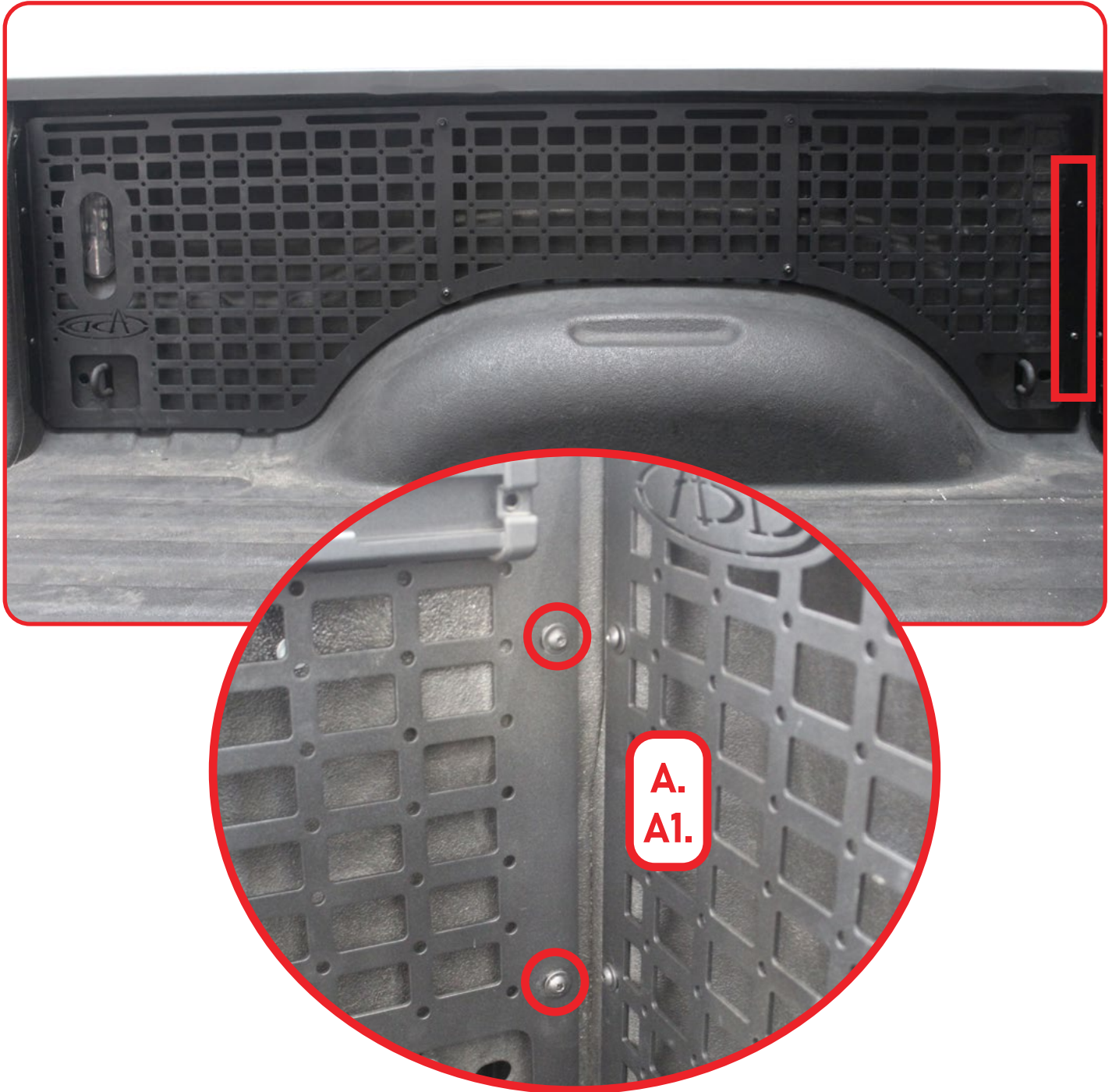

## BED SIDE MOLLE DRIVER 21-24/DODGE TRX

## INSTALL

### STEP 13

**(Optional step)** With a (5/32 allen) and (7/16 wrench) use the provided **(A, A1, A2)** hardware to install the tie down hook in the provided holes located on the top section of the Bed Side Molle as shown below.

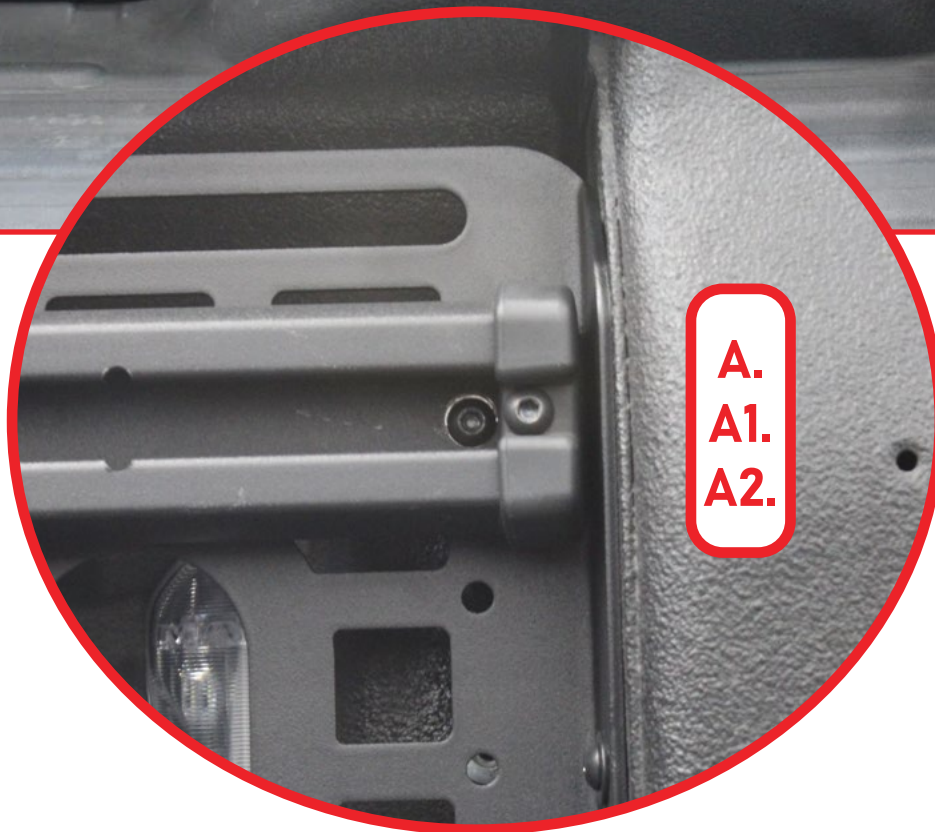

## BED SIDE MOLLE DRIVER 21-24/DODGE TRX

## FINAL

### STEP 14

Stand back and enjoy your new ADD Bed Side Molle.

Check and re-tighten, if needed, all mounting bolts after 100 miles and periodically thereafter.



THIS PRODUCT IS PROTECTED BY ONE OR MORE U.S. PATENTS  
[WWW.ADDICTIVEDESERTDESIGNS.COM/PATENTS](http://WWW.ADDICTIVEDESERTDESIGNS.COM/PATENTS)

FOR ADDITIONAL SUPPORT OR TECHNICAL QUESTIONS,  
PLEASE CALL 480-671-0820 OR  
EMAIL [INFO@ADDICTIVEDESERTDESIGNS.COM](mailto:INFO@ADDICTIVEDESERTDESIGNS.COM)