

2024/TOYOTA TACOMA

STEALTH CENTER MOUNT WINCH FRONT BUMPER

F6703412601NA



TOOLS REQUIRED

- (Allen) 5/32, 7/32
- (Wrench) 10mm, 12mm, 18mm, 7/16, 3/4
- (Socket) 10mm, 12mm, 18mm, 7/16, 3/4
- Flat Head/Fastener Remover
- Jigsaw
- Ratchet
- Marker



SKILL LEVEL

-Medium/Intermediate

****This installation requires 2 people for best results****



TIME REQUIRED

- 4 hours for OEM Removal/Bumper Install
- 1 Additional Hour to Wire Lights

****Labor Rates are based on a vehicle with no pre-existing damage. Wiring labor is based on a standard wiring procedure with light switches installed in an easily accessible location. Custom light triggering or switch mounting location will result in a greater labor charge.****



INCLUDED IN KIT

- 8- 1/4-20 X 3/4" Button Head Bolt
- 8- 1/4" Flat Washer
- 8- 1/4-20" Nylon Lock Nut
- 12- 1/2-13 X 1 1/2" Hex Head Bolt
- 24- 1/2" Flat Washer
- 12- 1/2-13" Nylon Lock Nut
- 8- 3/8-16 X 1" Button Head Bolt
- 8- 3/8-16" U-Nut

⚠️ WARNINGS/CAUTIONS BEFORE STARTING INSTALLATION ⚠️

-BEFORE YOU INSTALL THIS KIT-

Read and understand all instructions, warnings, cautions, & notes contained in this installation instruction guide. Consult your vehicle owner's manual for proper disconnection of electrical and lifting of vehicle if required for installation of this product.

This install may require some technical skills and knowledge of basic mechanical work. If you do not feel that you are capable of performing this install please take this product to a trained professional.

After reading this guide please contact us with any questions or concerns before installing product.
Customer Service (480) 671-0820

Addictive desert designs is *not* responsible for any bodily injury or harm to you or your vehicle as a result of an improper install.

Proper installation of this kit required knowledge of the factory recommended procedures for removal and installation of original equipment components.

We recommend that the factory shop manual and any special tools needed to service your vehicle be on hand during the installation. Installation of this kit without proper knowledge of the factory recommended procedures may affect the performance of these components and the safety of the vehicle.

Inspect all contents of this package to make sure product is not damaged and all installation hardware has been included. If parts are missing from kit, please be prepared to provide the following information:

1. Name of purchase location
2. Bar Code on side of box
3. Date above bar code
4. Date inside box cover

ALWAYS WEAR EYE PROTECTION WHEN OPERATING POWER TOOLS

HARDWARE/PARTS

A.



1/4-20 X 3/4" BUTTON HEAD

QTY: 8

A1.



1/4" FLAT WASHER

QTY: 8

A2.



1/4-20" NYLON LOCK NUT

QTY: 8

B.

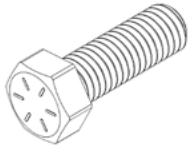

1/2-13 X 1 1/2" HEX HEAD

QTY: 12

B1.



1/2" FLAT WASHER

QTY: 24

B2.

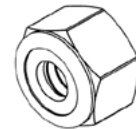

1/2-13" NYLON LOCK NUT

QTY: 12

C.



3/8-16 X 1" BUTTON HEAD

QTY: 10

C1.

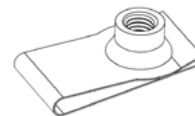

3/8-16" U-NUT

QTY: 10

Reference this page throughout the install

STEALTH CENTER MOUNT WINCH FRONT BUMPER 2024/TOYOTA TACOMA

REMOVAL

□ STEP 1

Using a (10mm socket) or a (Philips head Screwdriver), Remove the air dam hardware as shown below.

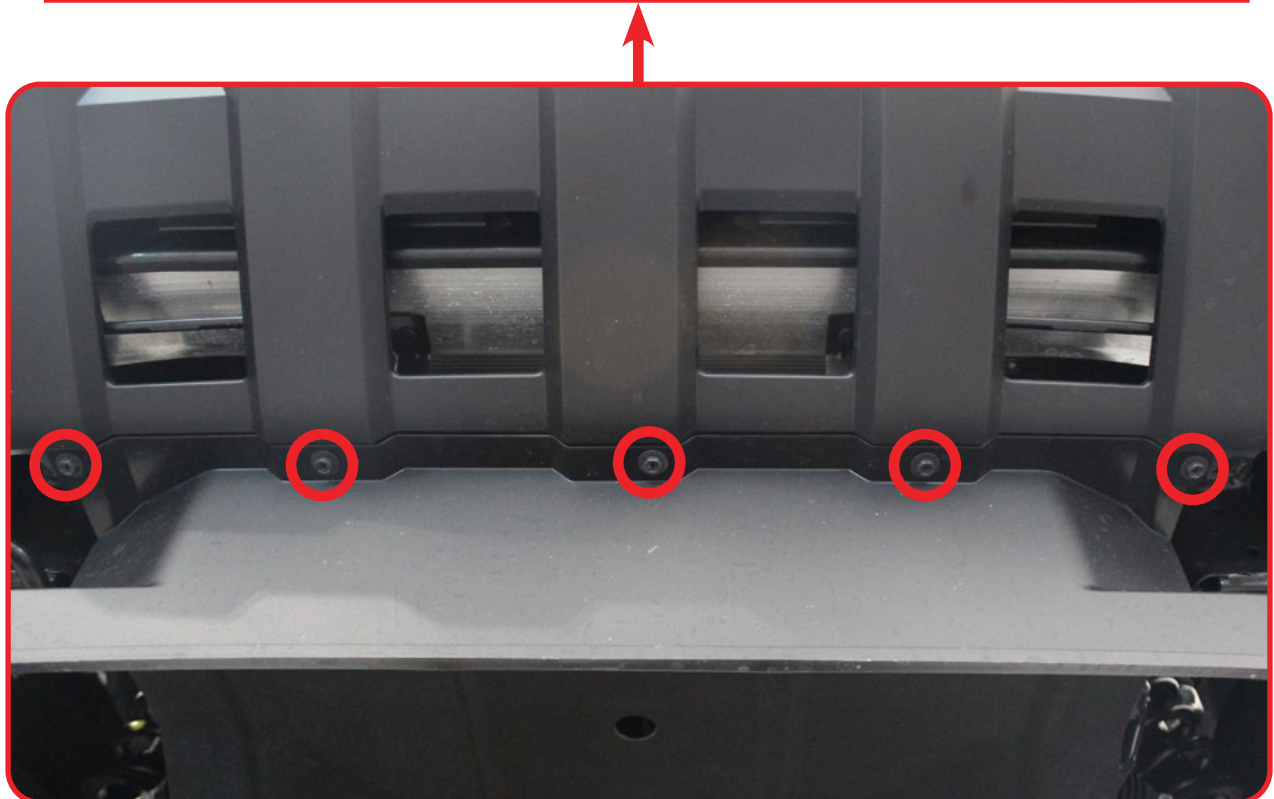

STEALTH CENTER MOUNT WINCH FRONT BUMPER 2024/TOYOTA TACOMA

REMOVAL

□ STEP 2

Using a (10mm socket) or a (Philips head Screwdriver), Remove the air dam hardware located in the wheel well as shown below.



STEALTH CENTER MOUNT WINCH FRONT BUMPER 2024/TOYOTA TACOMA

REMOVAL

□ STEP 3

Using a (12mm Socket), Remove the skid plate.

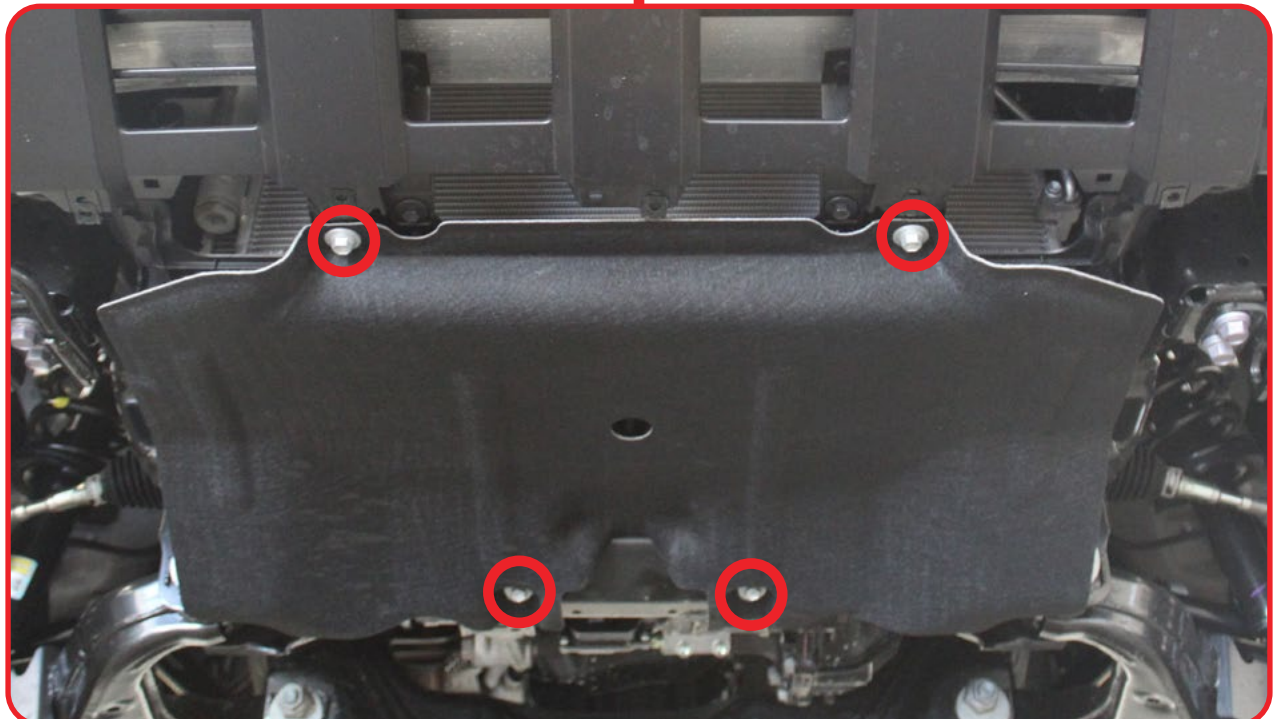

STEALTH CENTER MOUNT WINCH FRONT BUMPER 2024/TOYOTA TACOMA

REMOVAL

□ STEP 4

Using a (10mm socket), remove the 2x bolts located near the center of the front bumper as shown below.

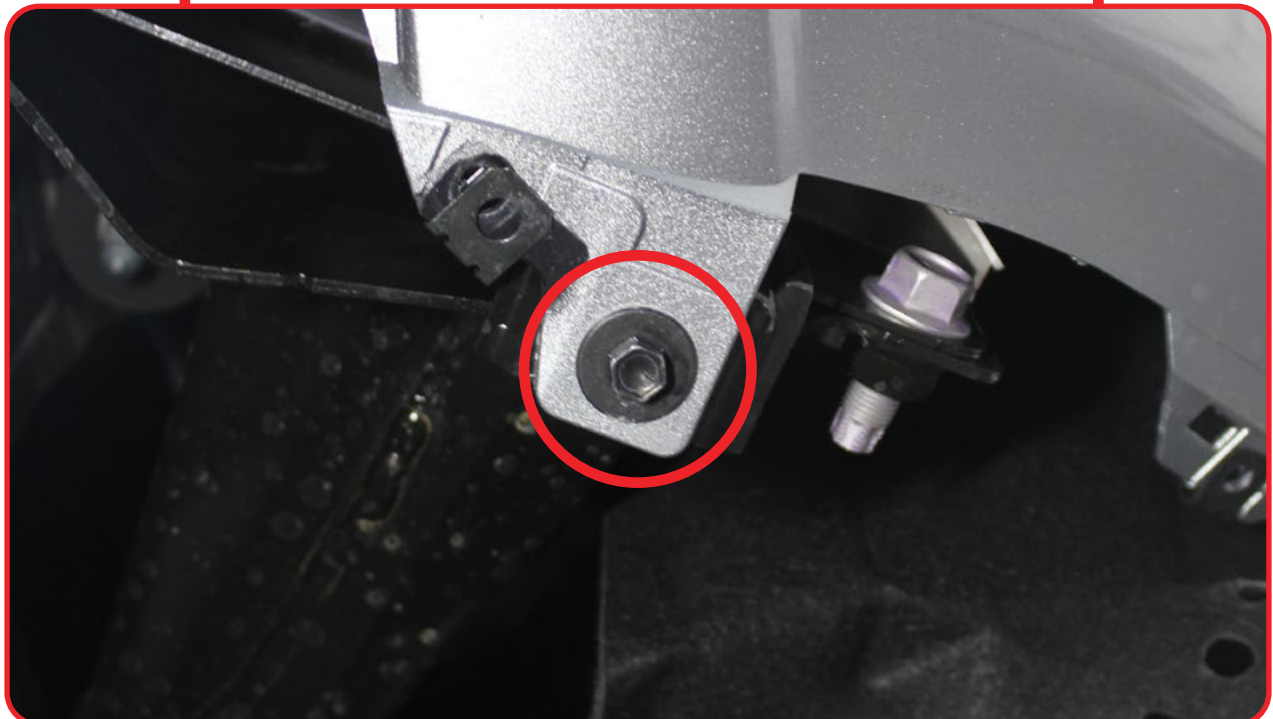

STEALTH CENTER MOUNT WINCH FRONT BUMPER 2024/TOYOTA TACOMA

REMOVAL

□ STEP 5

Open the hood and remove the 12x push pins by pushing the center down to release. Remove covers and set aside.



STEALTH CENTER MOUNT WINCH FRONT BUMPER 2024/TOYOTA TACOMA

REMOVAL

□ STEP 6

Using a (10mm socket) remove the 3x bolts as shown below.

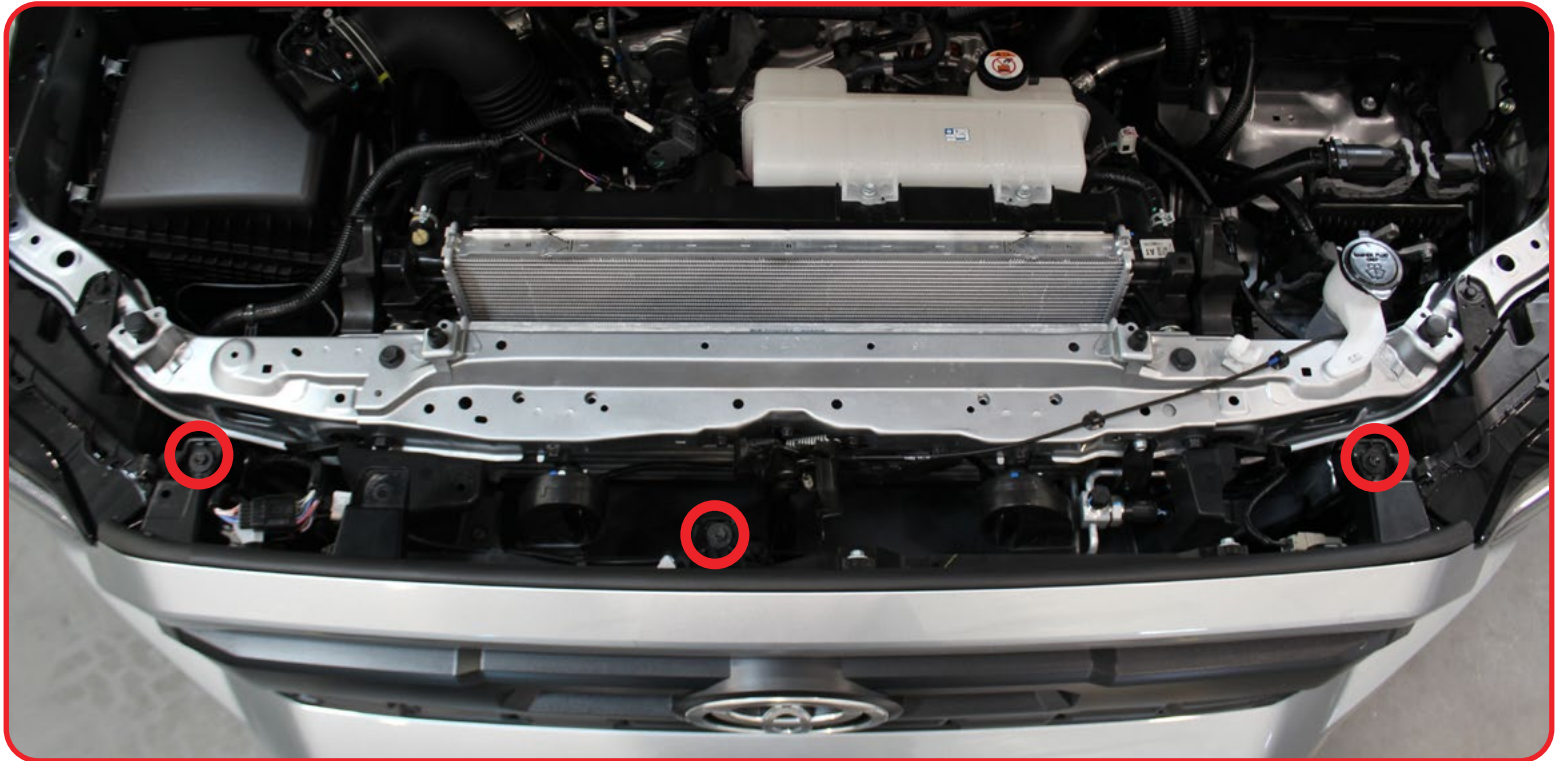

STEALTH CENTER MOUNT WINCH FRONT BUMPER 2024/TOYOTA TACOMA

REMOVAL

□ STEP 7

Unplug the wiring harness and front camera plugs located on driver and passenger side.

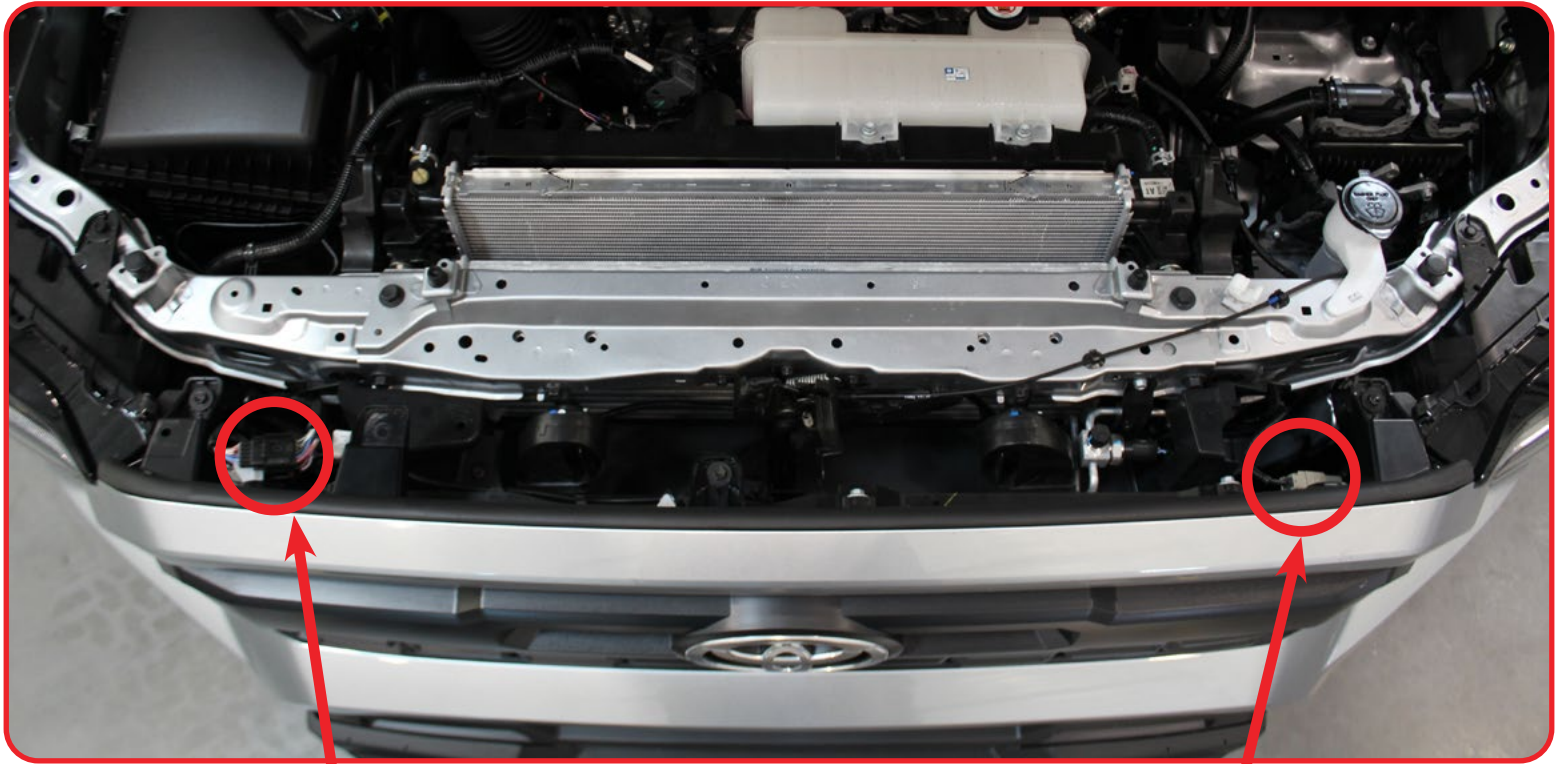

STEALTH CENTER MOUNT WINCH FRONT BUMPER 2024/TOYOTA TACOMA

REMOVAL

□ STEP 8

Using a (flathead screwdriver) and a (10mm socket), remove the 4x bolts as shown below on each side located inside the wheel well.



STEALTH CENTER MOUNT WINCH FRONT BUMPER 2024/TOYOTA TACOMA

REMOVAL

□ STEP 9

Pull the fender flair outwards to separate the bumper and grill from the inner fender liner.



STEALTH CENTER MOUNT WINCH FRONT BUMPER 2024/TOYOTA TACOMA

REMOVAL

□ STEP 10

Using a (Philips head screwdriver), remove the bolts located behind the fender flair as shown below. You can now remove the bumper/grill assembly.



STEALTH CENTER MOUNT WINCH FRONT BUMPER 2024/TOYOTA TACOMA

REMOVAL

□ STEP 11

Using a (18mm socket), remove the 4x bolts located on top of the crash bar as shown below.

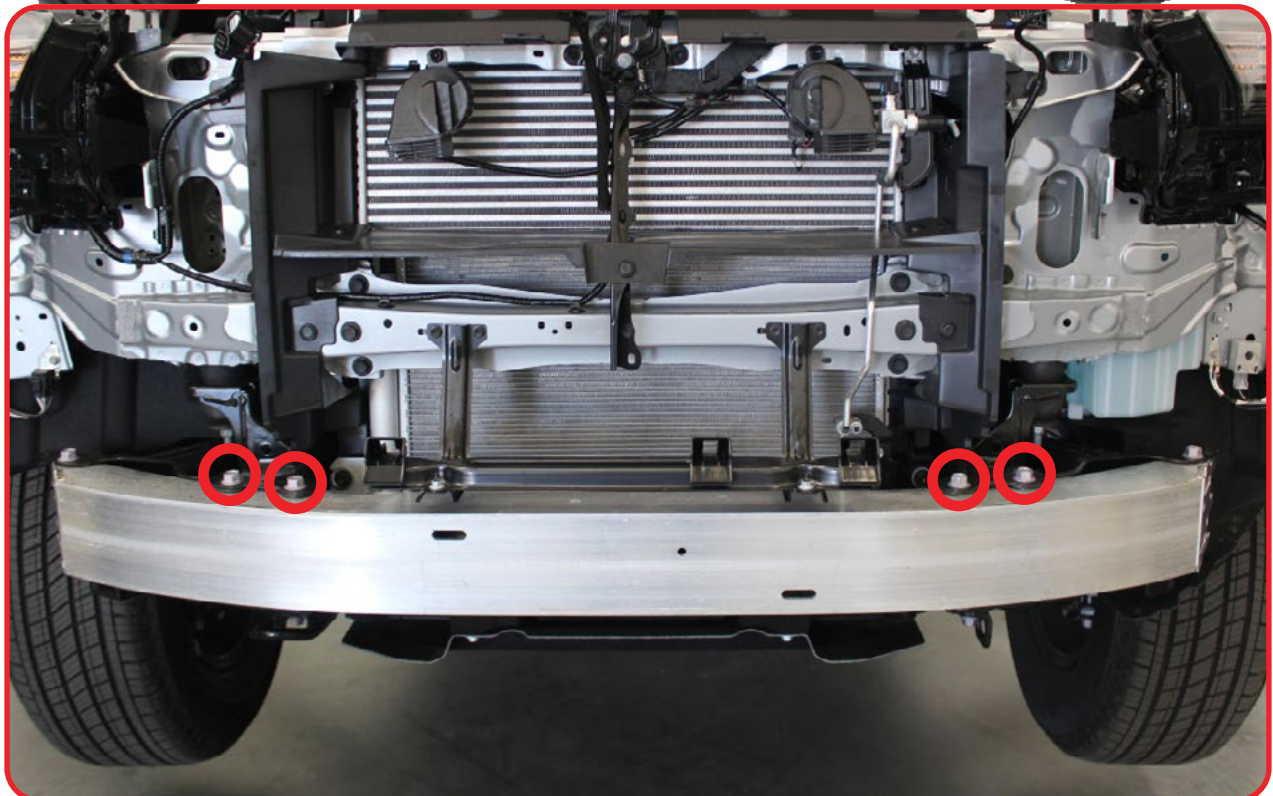
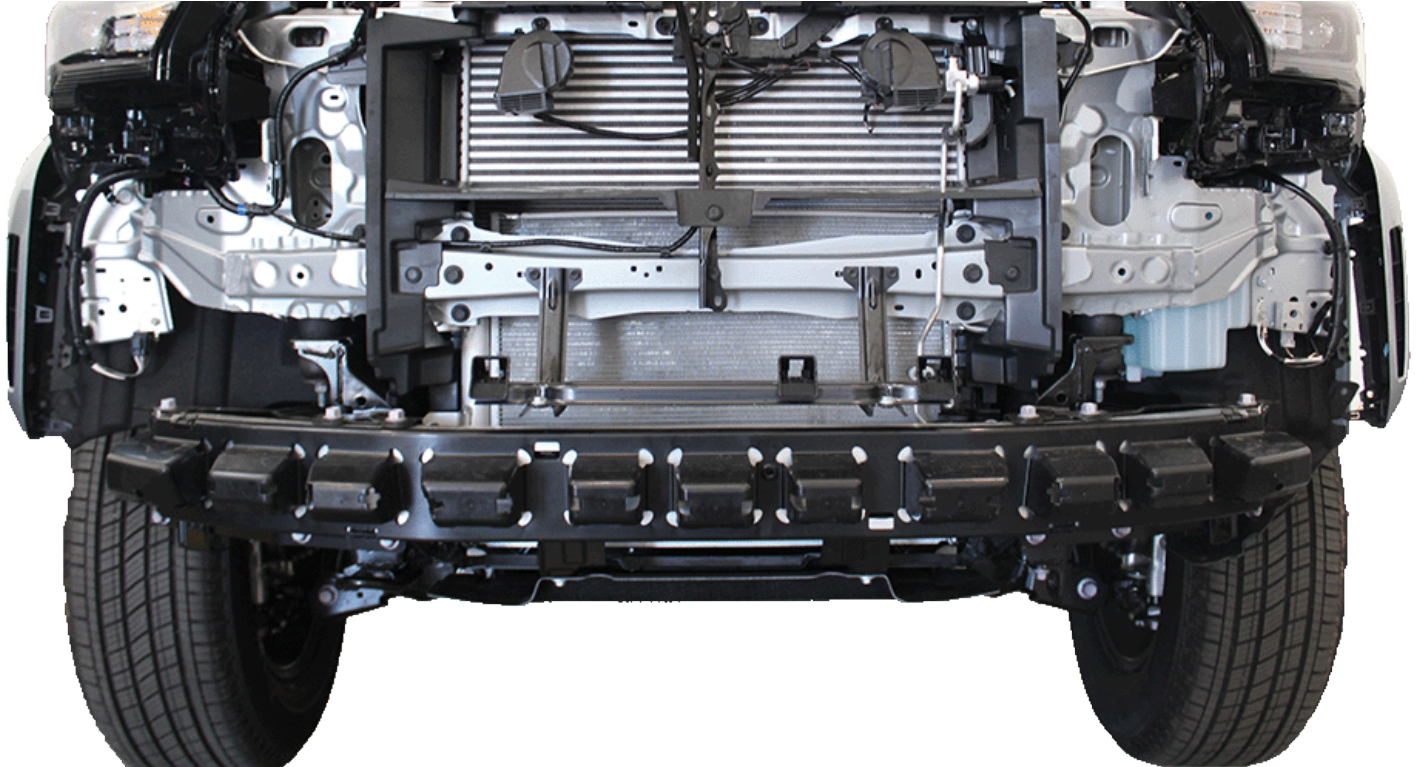

STEALTH CENTER MOUNT WINCH FRONT BUMPER 2024/TOYOTA TACOMA

REMOVAL

□ STEP 12

Using a (18mm socket), remove the 4x bolts located under the crash bar as shown below. You can now remove the crash bar.

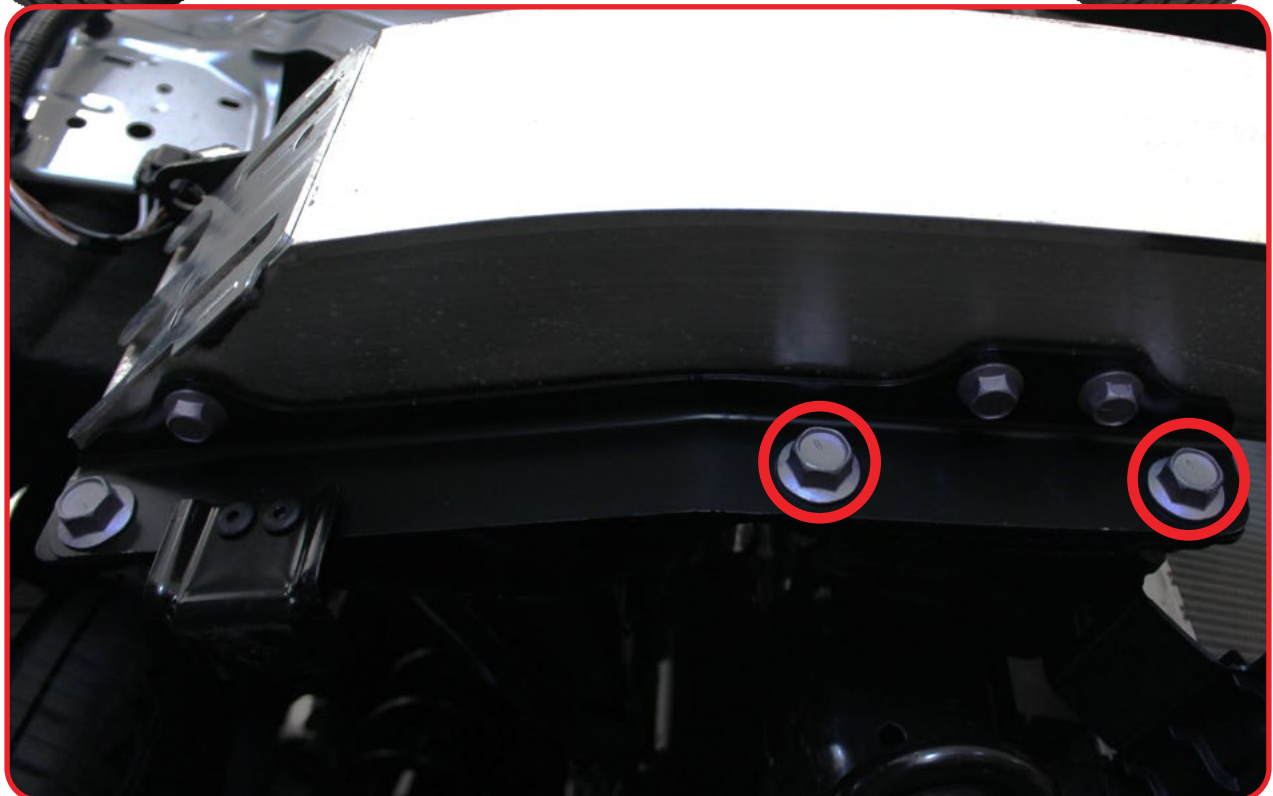
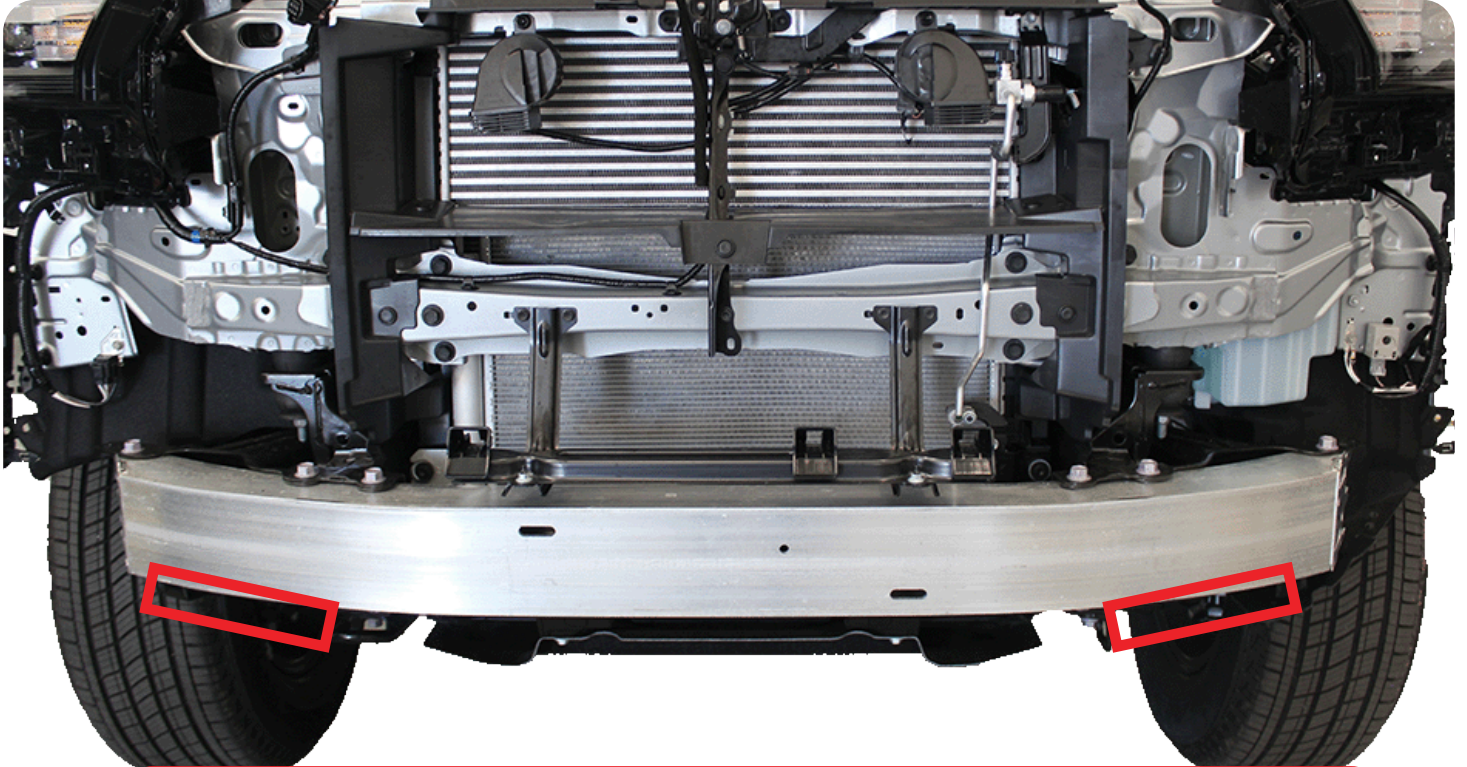

STEALTH CENTER MOUNT WINCH FRONT BUMPER 2024/TOYOTA TACOMA

REMOVAL

□ STEP 13

Using a (flat head screwdriver), remove the 6x push pins holding the lower shroud located on the inside of the frame rails in front of the intercooler.

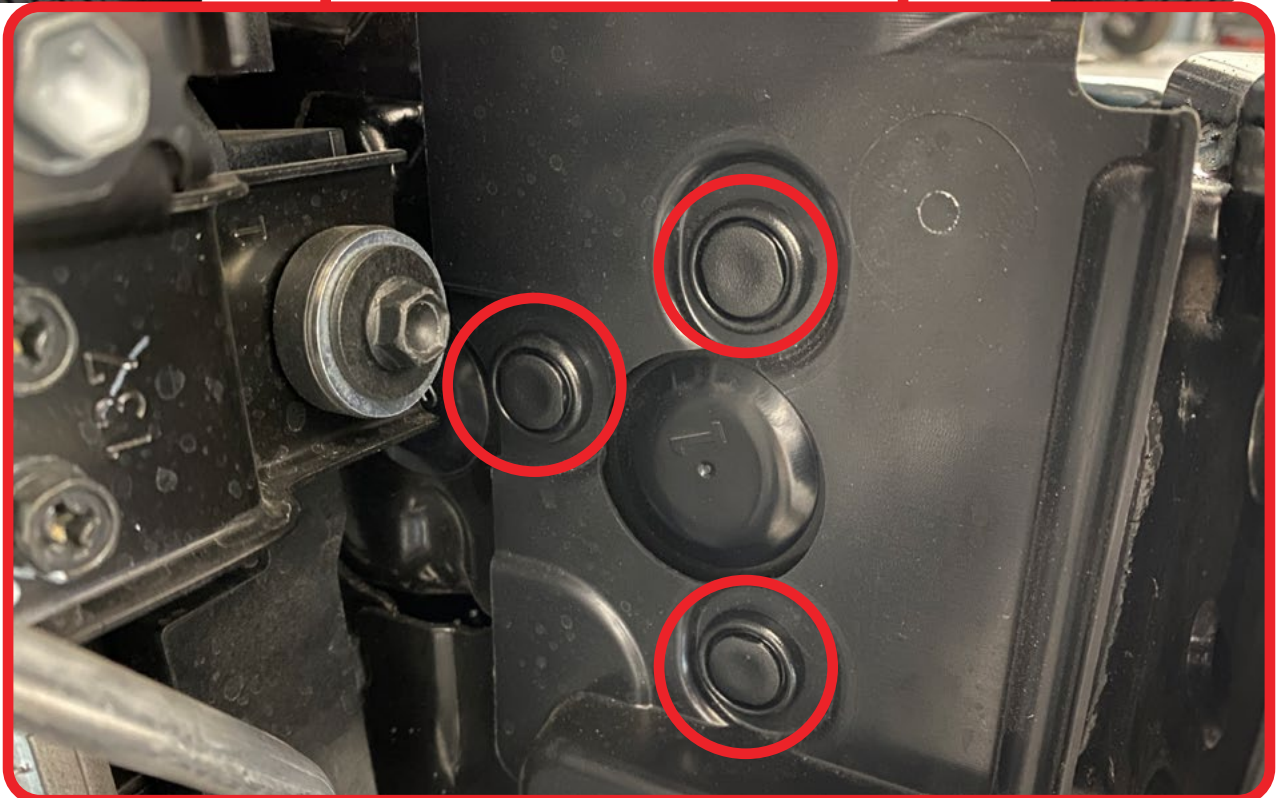
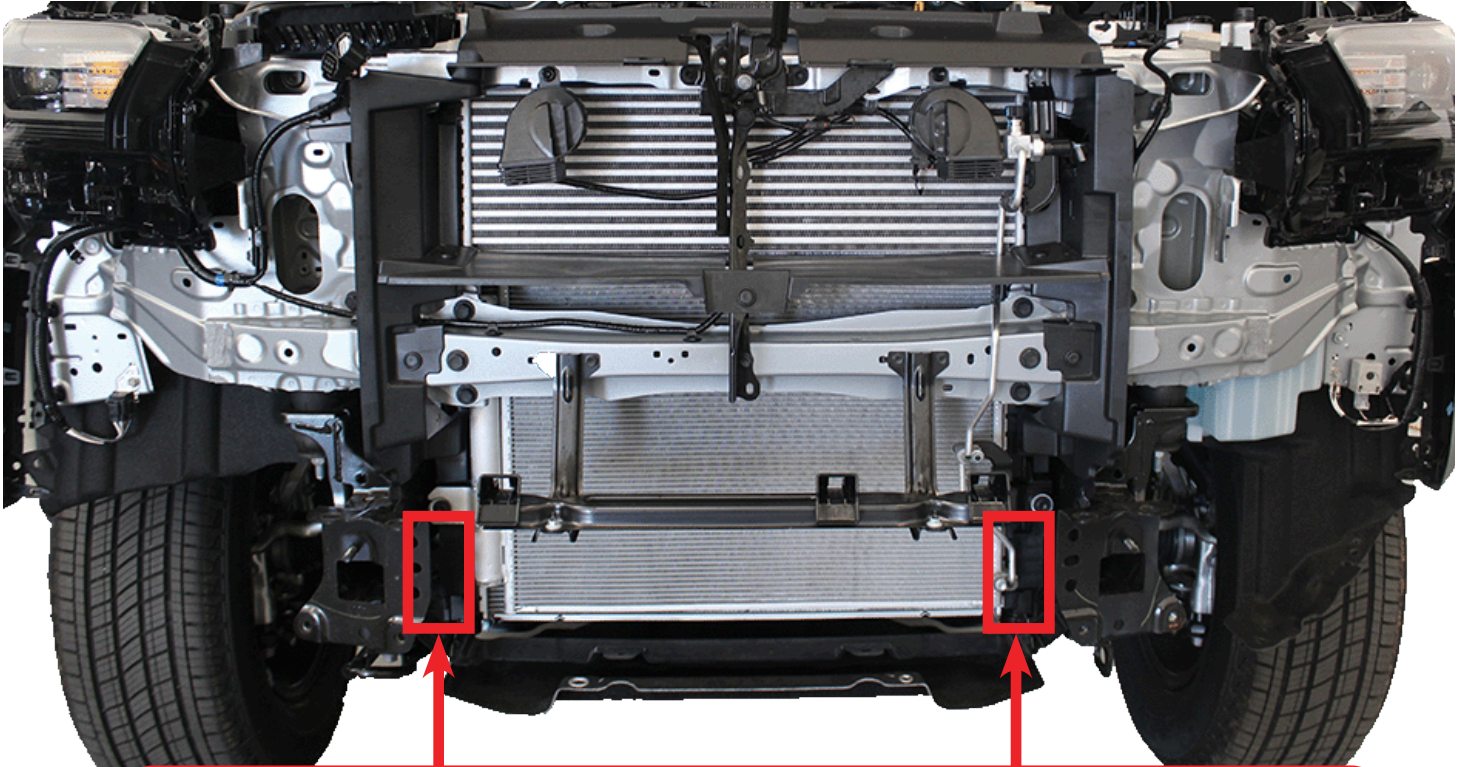

STEALTH CENTER MOUNT WINCH FRONT BUMPER 2024/TOYOTA TACOMA

REMOVAL

□ STEP 14

Using a (18mm socket), Remove the tow hooks as shown below.

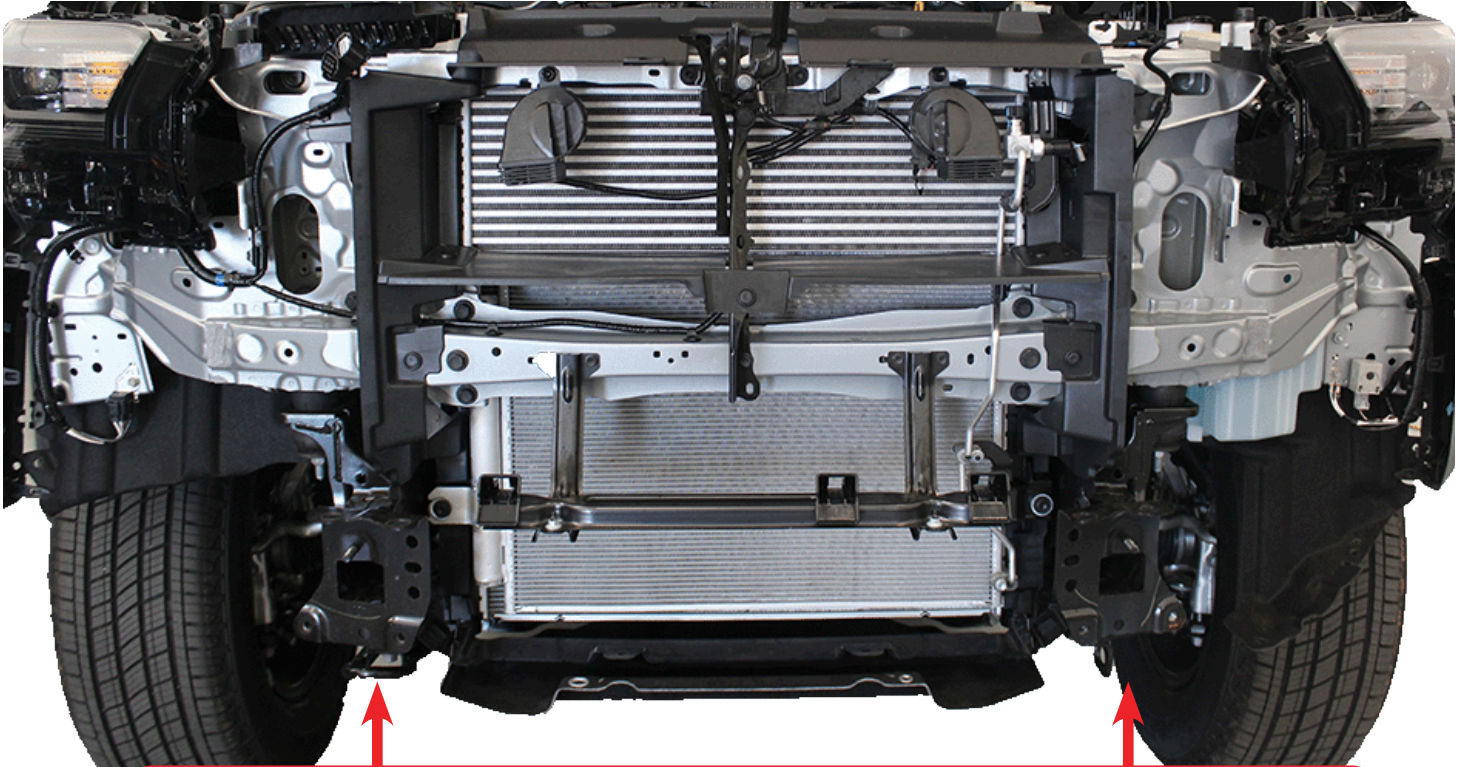

STEALTH CENTER MOUNT WINCH FRONT BUMPER 2024/TOYOTA TACOMA

REMOVAL

□ STEP 15

Using a (philips head screwdriver), remove the 4x screws holding the center section and pull the center plastic on the front side of the bumper off.

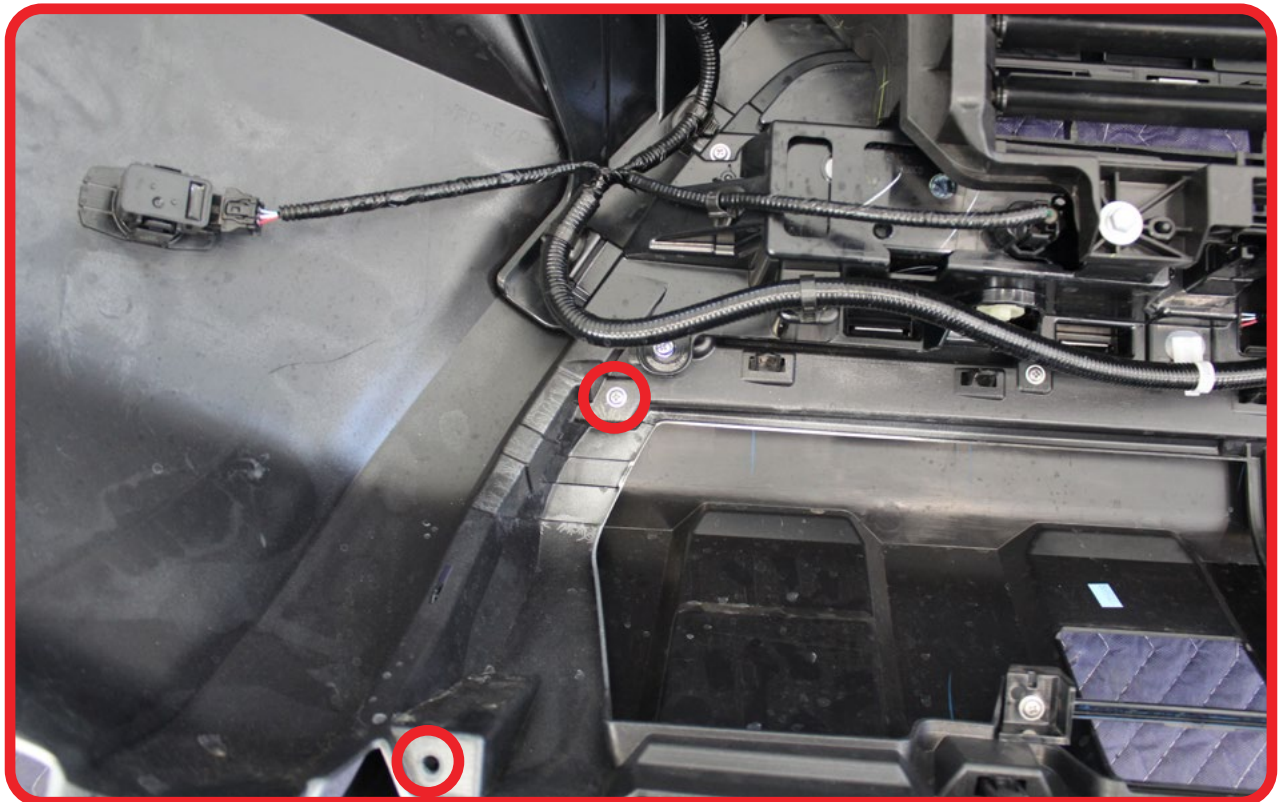
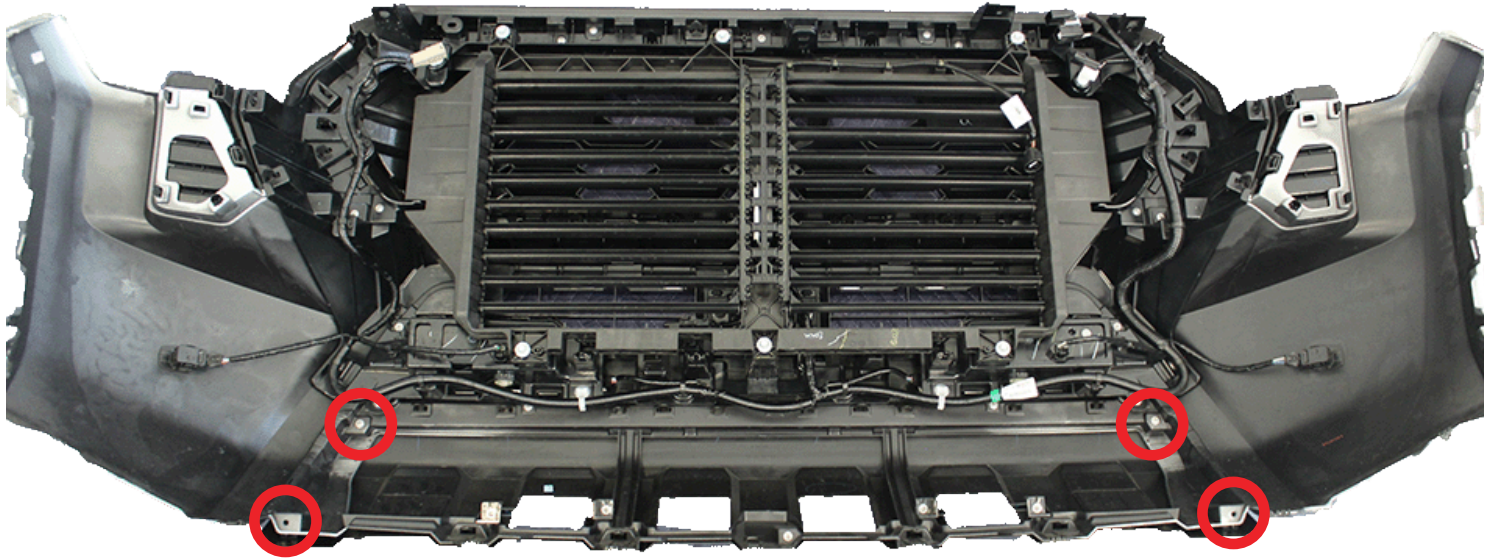

STEALTH CENTER MOUNT WINCH FRONT BUMPER 2024/TOYOTA TACOMA

REMOVAL

□ STEP 16

Using a (marker), draw a line on the underside of the plastic as shown in **FIG. 1**. This will be the line you will follow when cutting. After marking the cut line, remove the 4x screws holding the plastic from the backside using a (Philips head screwdriver) as shown in **FIG. 2**.

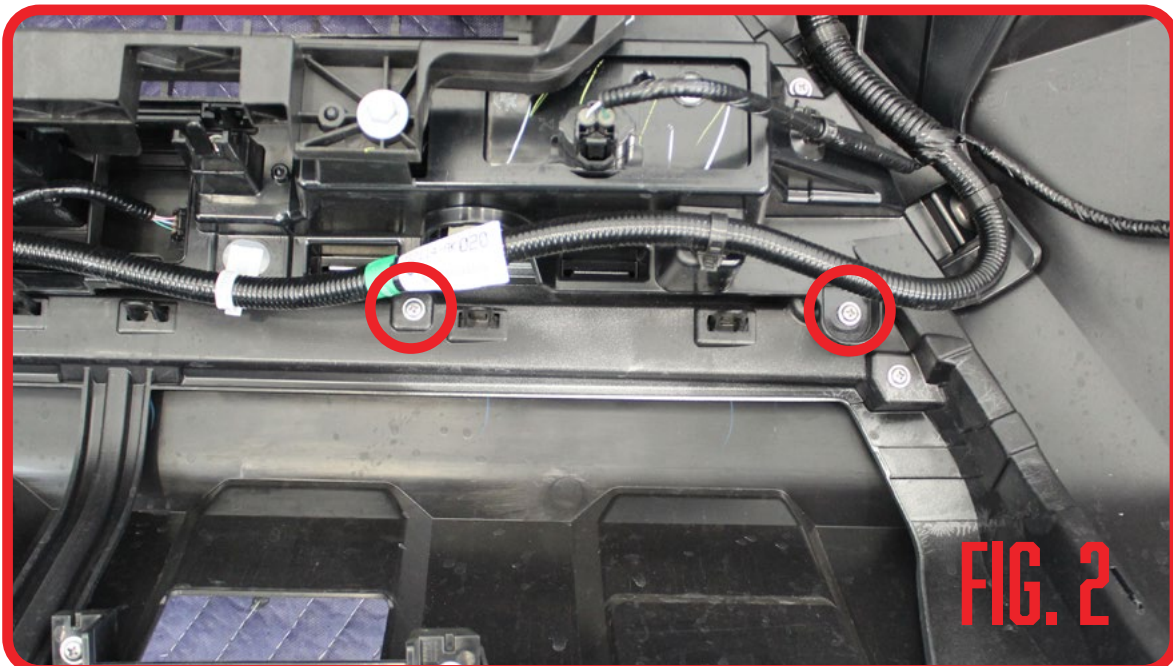
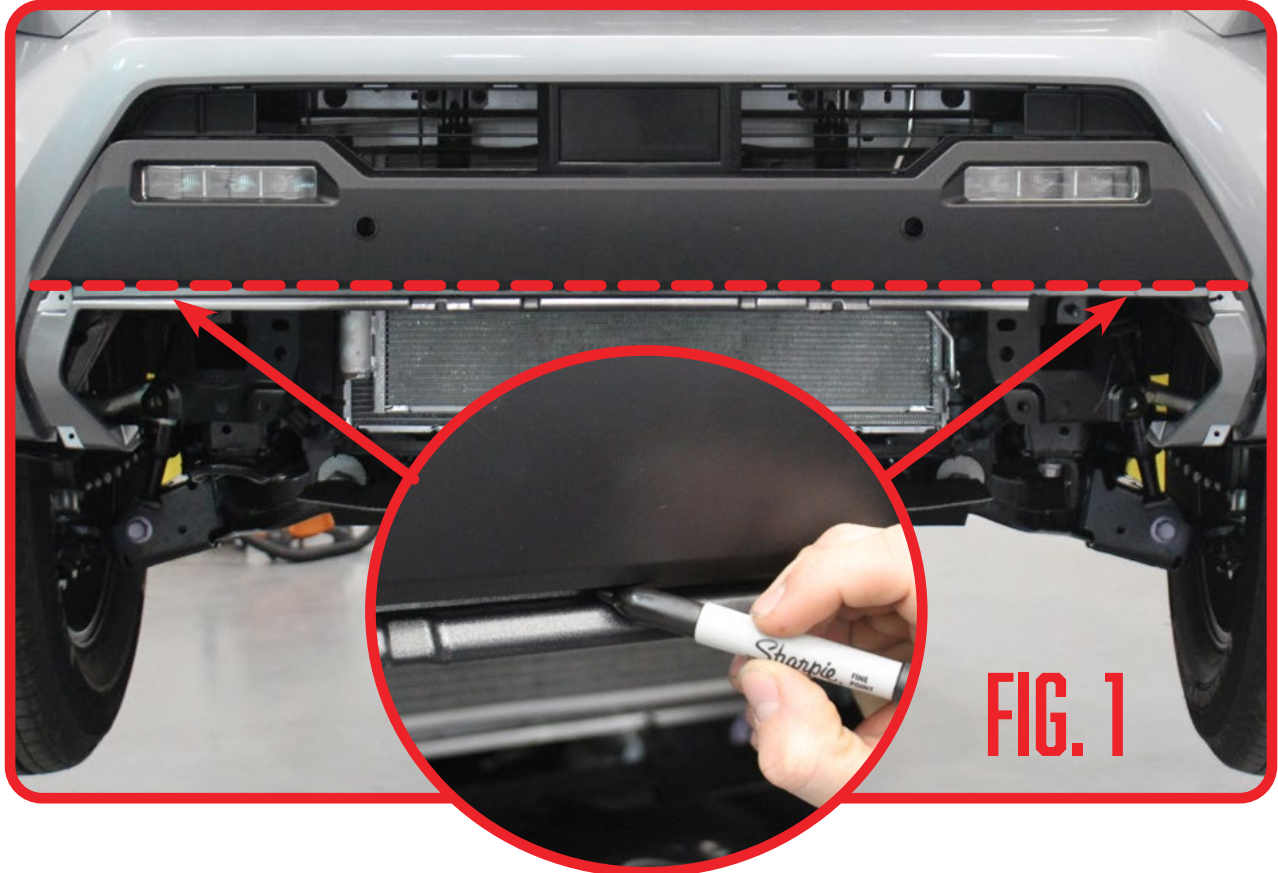

STEALTH CENTER MOUNT WINCH FRONT BUMPER 2024/TOYOTA TACOMA

REMOVAL

□ STEP 17

Using a (jigsaw), cut along the edge as shown in FIG. 3 and cutting the line drawn from step 15.

****Avoid the wiring harness while cutting located above the line drawn from step 15****

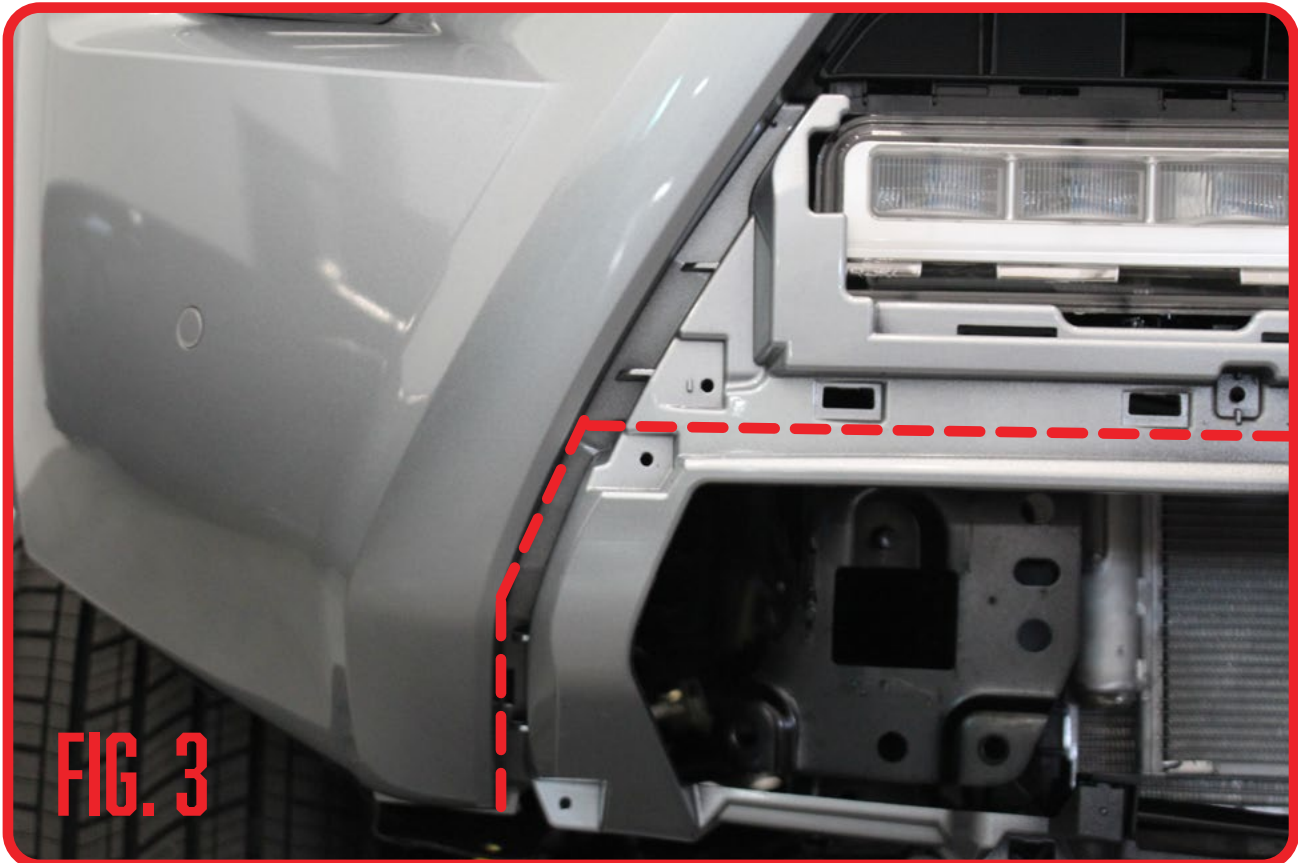

FIG. 3

STEALTH CENTER MOUNT WINCH FRONT BUMPER 2024/TOYOTA TACOMA

INSTALL

□ STEP 18

Install the winch mount with the provided (**B, B1, B2**) hardware using a (3/4 wrench) and a (3/4 socket). (**INSTALL WINCH BEFORE MOUNTING TO THE TRUCK**)

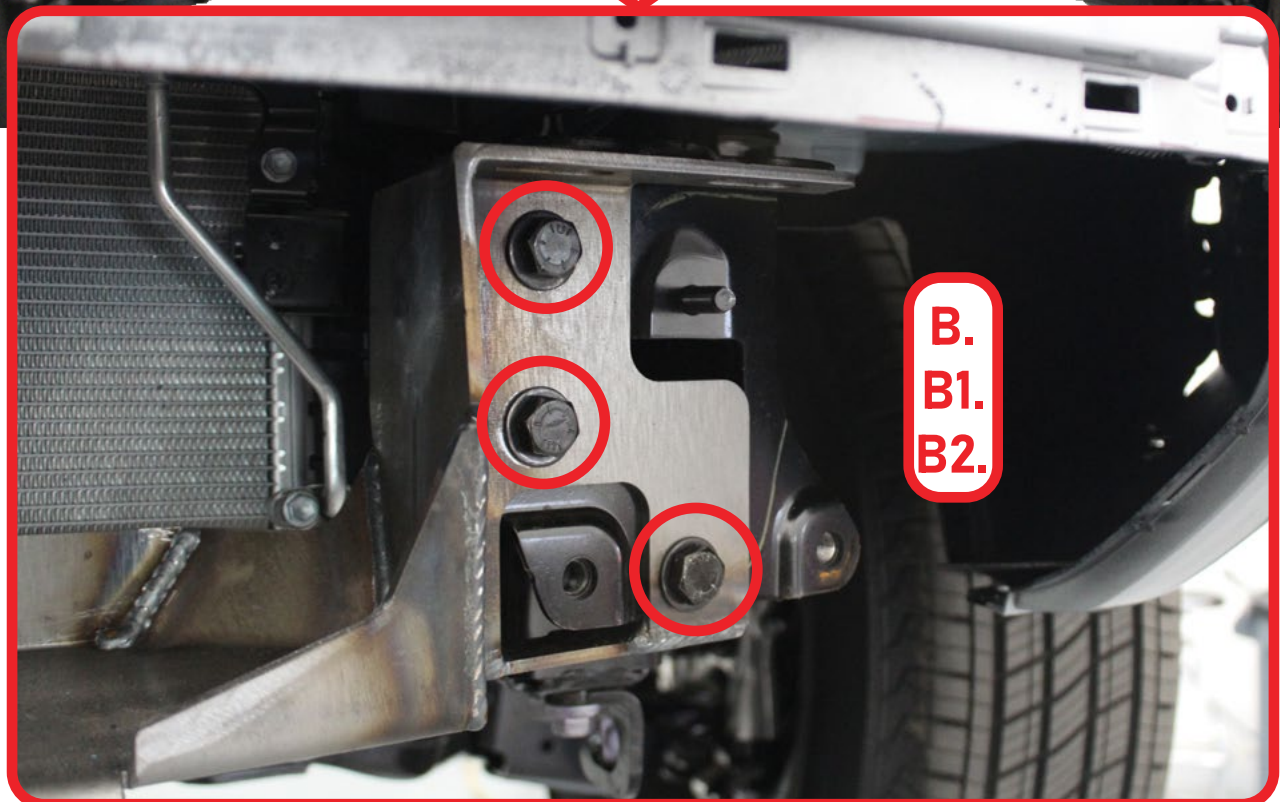

STEALTH CENTER MOUNT WINCH FRONT BUMPER 2024/TOYOTA TACOMA

INSTALL

□ STEP 19

Install the provided light mounts with the provided (A, A1, A2) 1/4" hardware using a (5/32 allen) and a (7/16 wrench). Now will be a good time to mount the light.

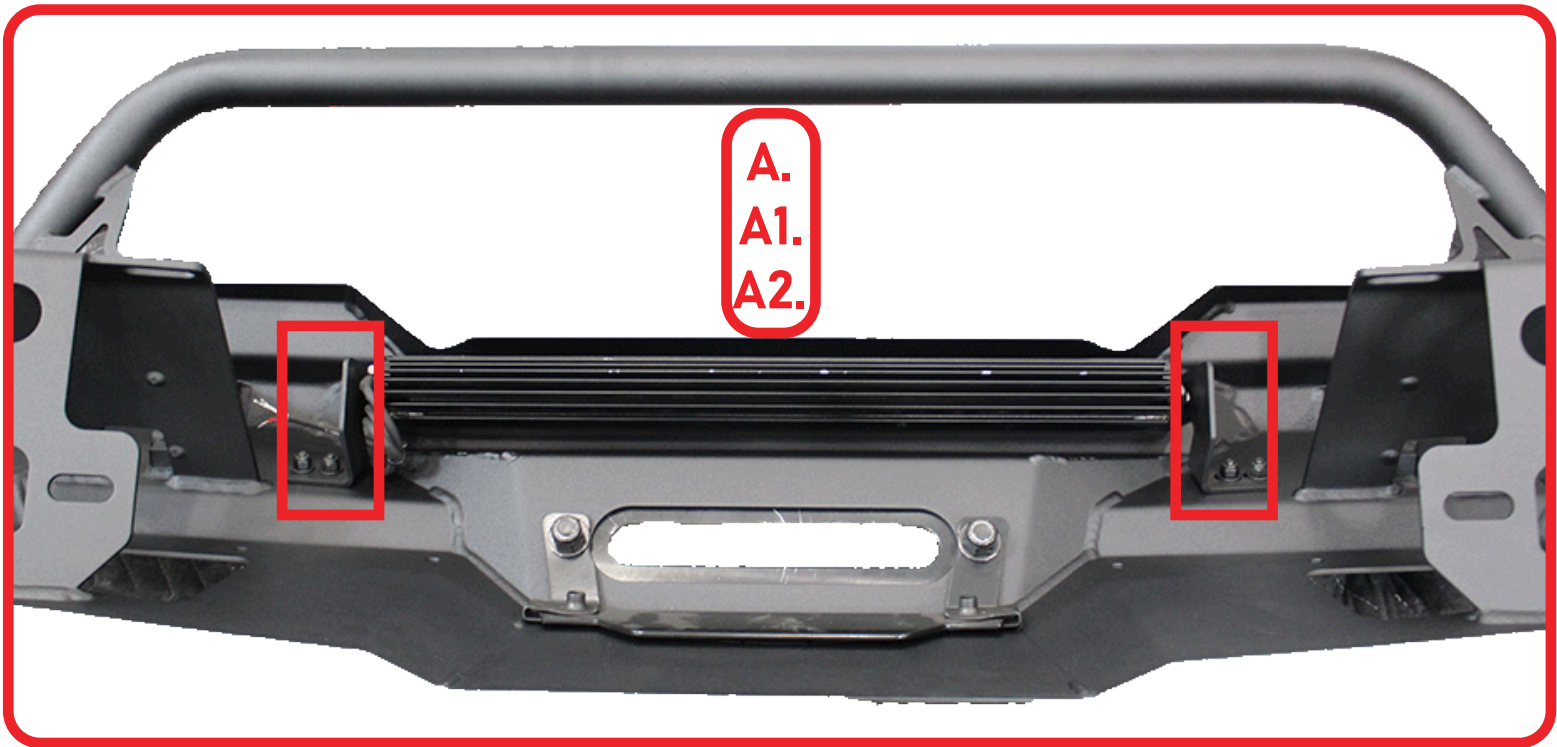
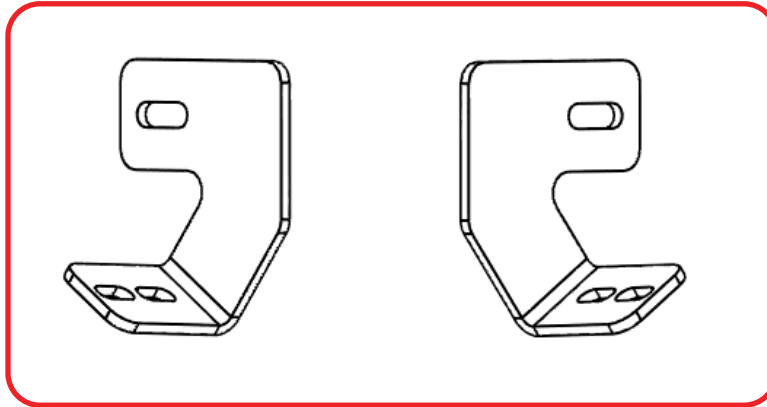

STEALTH CENTER MOUNT WINCH FRONT BUMPER 2024/TOYOTA TACOMA

INSTALL

□ STEP 20

Using the provided (C) nut clips, install the mount plate with the fairlead of your choice as shown below.

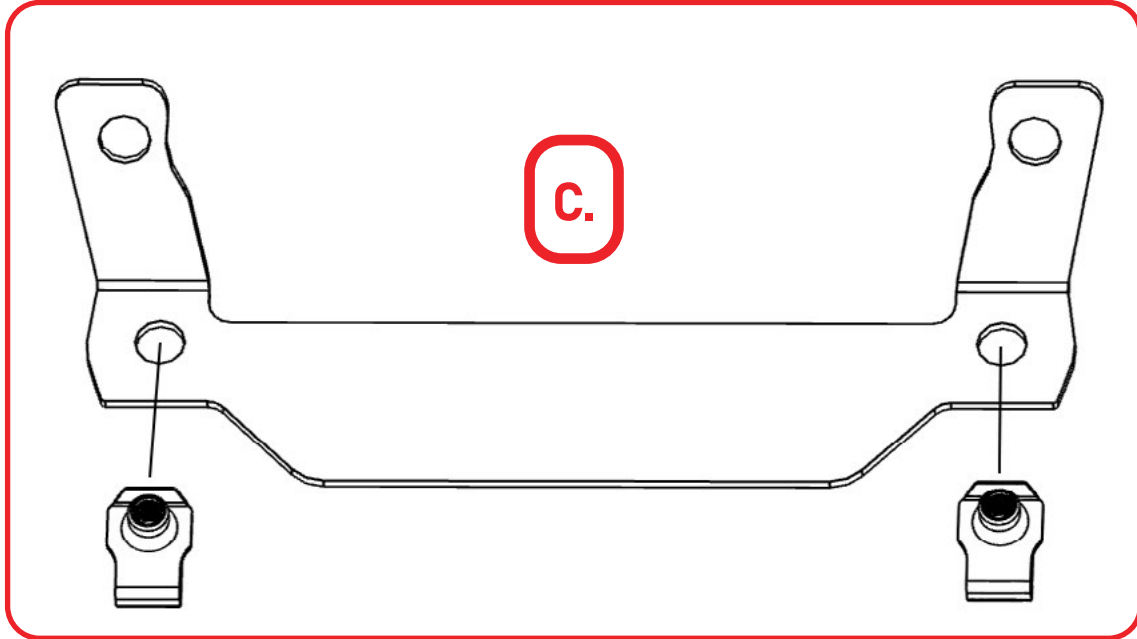

STEALTH CENTER MOUNT WINCH FRONT BUMPER 2024/TOYOTA TACOMA

INSTALL

□ STEP 21

With a helping hand, you can now install the bumper using a (18mm socket) with the hardware removed from **step 11**.

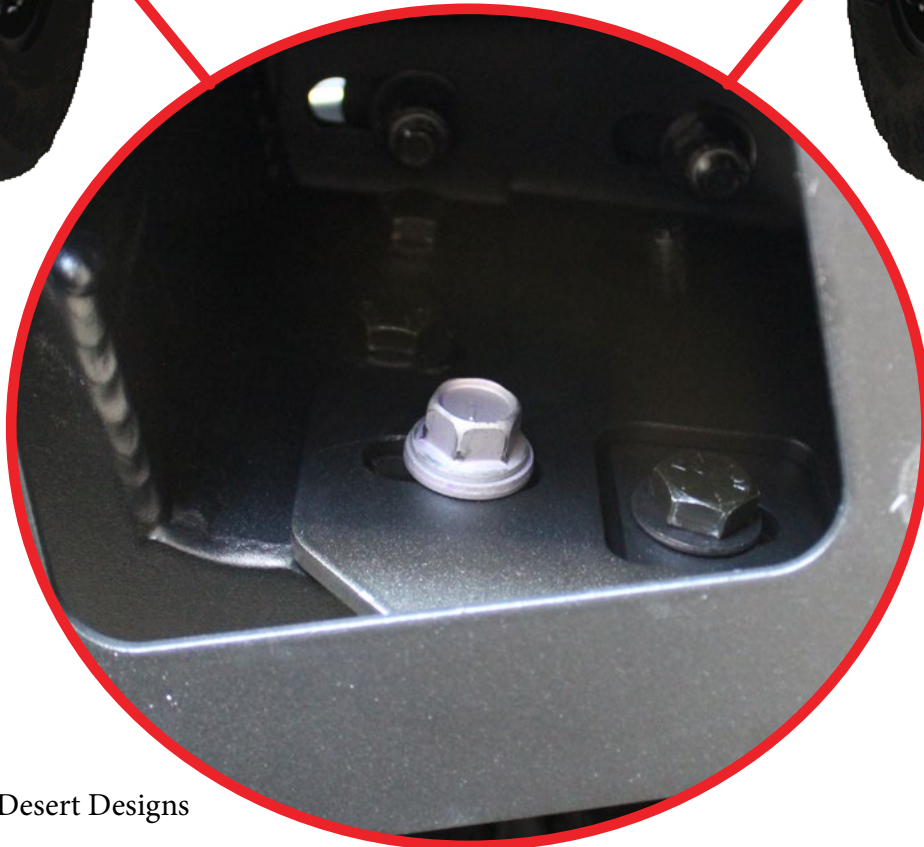

STEALTH CENTER MOUNT WINCH FRONT BUMPER 2024/TOYOTA TACOMA

INSTALL

□ STEP 22

Install the provided (C) nut clips with the backer plates as shown below. Next, slip the backer plates inside the bumper and install with the provided (C1) 3/8" hardware using a (7/32 allen).

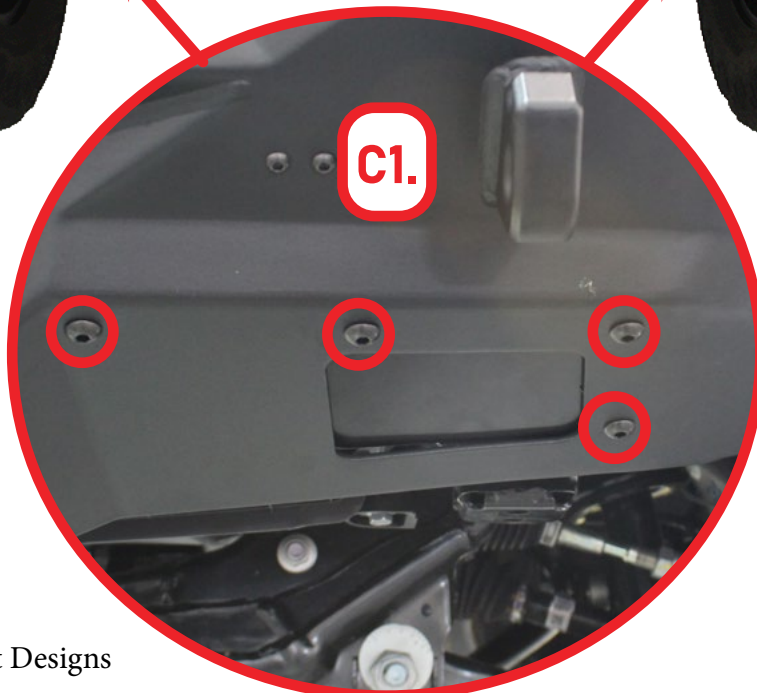
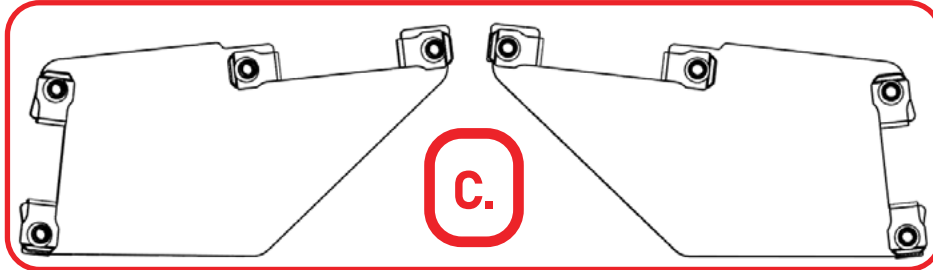

STEALTH CENTER MOUNT WINCH FRONT BUMPER 2024/TOYOTA TACOMA

INSTALL

□ STEP 23

Install the support brackets with the provided **(A, A1, A2)** 1/4" hardware using (5/32 Allen) and a (7/16 wrench). Next install the provided **(B, B1, B2)** 1/2" hardware using a (3/4 socket) and a (3/4 wrench).

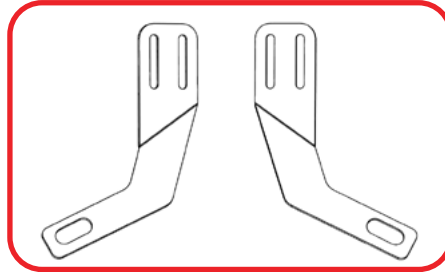

A.
A1.
A2.

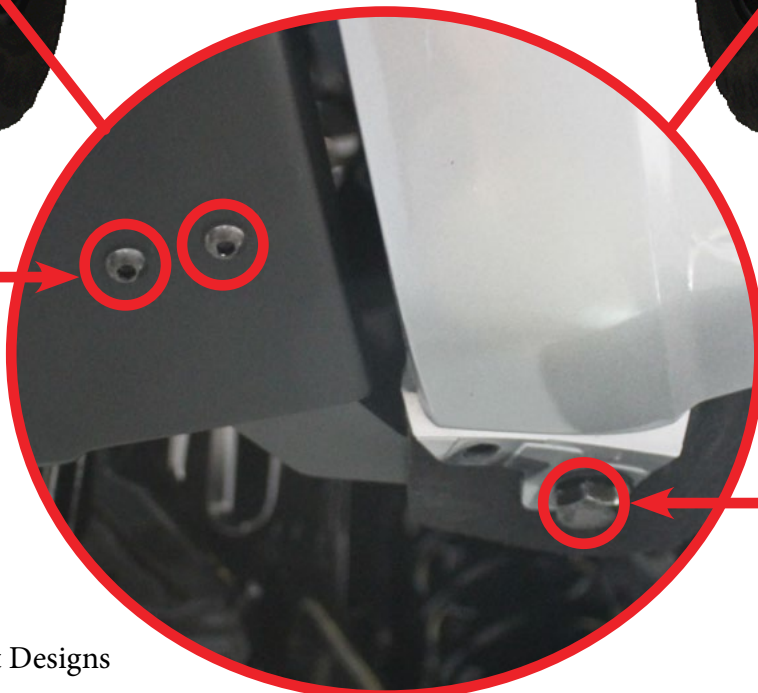

B.
B1.
B2.

STEALTH CENTER MOUNT WINCH FRONT BUMPER 2024/TOYOTA TACOMA

FINAL

STEP 24

Stand back and enjoy your new ADD Stealth Center Mount Winch Front Bumper.

Check and re-tighten, if needed, all mounting bolts after 100 miles and periodically thereafter.



THIS PRODUCT IS PROTECTED BY ONE OR MORE U.S. PATENTS
WWW.ADDICTIVEDESERTDESIGNS.COM/PATENTS

FOR ADDITIONAL SUPPORT OR TECHNICAL QUESTIONS,
PLEASE CALL 480-671-0820 OR
EMAIL INFO@ADDICTIVEDESERTDESIGNS.COM